

**PL:**  
NIE WYRZUCAJ.  
TENDOKUMENT JEST WAŻNY.  
ZATRZYMAJ GO!  
NINIEJSZA INSTRUKCJA MONTAŻU MA  
JEDYNIIE CHARAKTER POGLĄDOWY!

**EN:**  
DO NOT THROW AWAY.  
THIS DOCUMENT IS IMPORTANT.  
KEEP IT!  
THIS INSTALLATION GUIDE IS FOR  
REFERENCE ONLY!

**DE:**  
NICHT WEGWERFEN.  
DIESES DOKUMENT IST WICHTIG.  
BEHALTE ES!  
DIESE INSTALLATIONSANLEITUNG DIENT  
NUR ZUR ORIENTIERUNG!

**FR:**  
NE JETEZ PAS.  
CE DOCUMENT EST IMPORTANT.  
GARDEZ-LE!  
CE GUIDE D'INSTALLATION EST  
UNIQUEMENT À TITRE DE RÉFÉRENCE!

**IT:**  
NON BUTTARE VIA.  
QUESTO DOCUMENTO È IMPORTANTE.  
CONSERVALO!  
QUESTA GUIDA ALL'INSTALLAZIONE È  
SOLO DI RIFERIMENTO!

**ES:**  
NO LO TIRE.  
ESTE DOCUMENTO ES IMPORTANTE.  
GUÁRDELO!  
ESTA GUÍA DE INSTALACIÓN ES SOLO  
PARA REFERENCIA!

**NL:**  
NIET WEGGOOIEN.  
DIT DOCUMENT IS BELANGRIJK.  
BEWAAR HET!  
DEZE INSTALLATIEHANDLEIDING IS  
ALLEEN TER REFERENTIE!

**SE:**  
KASTA INTE BORT.  
DETTA DOKUMENT ÄR VIKTIGT.  
BEHÅLL DET!  
DENNA INSTALLATIONSGUIDE ÄR  
ENDAST FÖR REFERENS!

**PT:**  
NÃO DEITE FORA.  
ESTE DOCUMENTO É IMPORTANTE.  
GUARDE-O!  
ESTE GUIA DE INSTALAÇÃO É APENAS  
PARA REFERÊNCIA!

**RO:**  
NU ARUNCA.  
ACEST DOCUMENT ESTE IMPORTANT.  
PĂSTREAZĂ-L!  
ACEST GHID DE INSTALARE ESTE DOAR  
PENTRU REFERINȚĂ!

**HU:**  
NE DOBJA KI.  
EZ A DOKUMENTUM FONTOS.  
ŐRIZZE MEG!  
EZ A TELEPÍTÉSI ÚTMUTATÓ CSAK  
TÁJÉKOZTATÓ JELLEGŰ!

**BG:**  
НЕ ИЗХВЪРЛЯЙТЕ.  
ТОЗИ ДОКУМЕНТ Е ВАЖЕН.  
ЗАПАЗЕТЕ ГО!  
ТАЗИ ИНСТРУКЦИЯ ЗА МОНТАЖ Е  
САМО ЗА СПРАВКА!

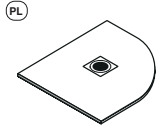

#### MONTAŻ BRODZIKA

1. Weryfikacja początkowa
2. Przygotowanie podłoża
3. Montaż brodzika
4. Czyszczenie
5. Utrzymanie
6. Wskazówki



#### Niezbędne narzędzia:

Taśma pomiarowa, Taśma malarska, Zaprawaklejowa, Zaprawaklejowa, Wiadro, Rękawice, Dozownik z uszczelniaczem silikonowym, Poziomica, Śrubokręt, Ołówek, Kielnia



### 1. WERYFIKACJA POCZĄTKOWA

1.1 Sprawdź, czy brodzik nie wygląda na odkształcony i nie ma żadnych uchybień ani zadrapań. Sprawdź, czy model, kolor i tekstura są prawidłowe. Po zainstalowaniu nie są akceptowane wymiana ani reklamacje z wymienionych powyżej powodów.

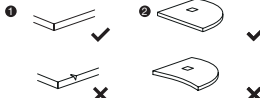
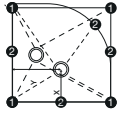

1.2

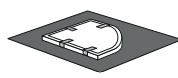

Brodzik należy przechowywać w pozycji poziomej, uważając, aby nie zarysować brodzika śrubami lub ostnąg.

1.3

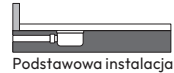

Podstawowa instalacja.



Instalacja na poziomopodłogi.

1.4

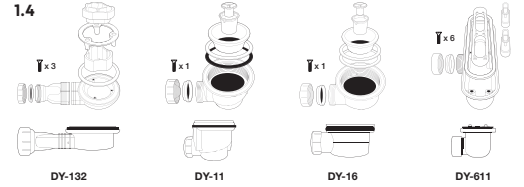

Sprawdź dokładnie wszystkie elementy zaworu spustowego, które otrzymasz.

### 2. PRZYGOTOWANIE PODŁOŻA.

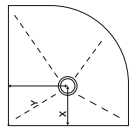

2.1 Aby zamontować, odpływ musi pokrywać się ze środkiem odpływu brodzika.

2.4

2.4M Należy uzyskać stałą solidną podstawę, nie odkształconą i całkowicie wyrównaną za pomocą materiału cementowego. Upewnij się, że otwór wokół zaworu nie jest wyższy o 2 cm i nie znajduje się poniżej poziomu podstawy.

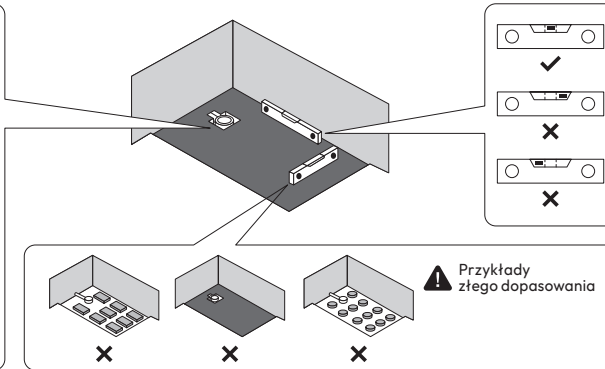
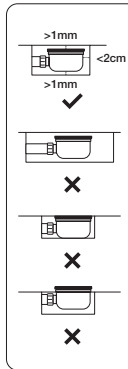

Przykłady złego dopasowania

2.2

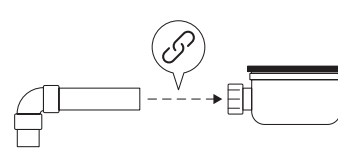

Sprawdź połączenie między odpływem a rurą odpływową, upewnij się, że nalewając wodę do odpływu nie ma wycieku w połączeniu wanny.

2.3

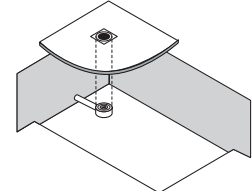

Zainstaluj odpływ aby pokrywał się ze środkiem odpływu brodzika.

### 3. MONTAŻ BRODZIKA.

Przed nałożeniem kleju i kontynuowaniem montażu, brodzik należy położyć na podstawie i podłączyć odpływ. Wlej obficie wodę. Sprawdź, czy woda przepływa bezpośrednio do odpływu. Ta weryfikacja jest bardzo ważna, nie przyjmujemy żadnych reklamacji, wymiana i zwrotu kosztów po zamontowaniu brodzika.

3.1

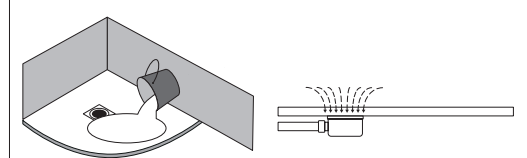

3.2 Montaż odpływu

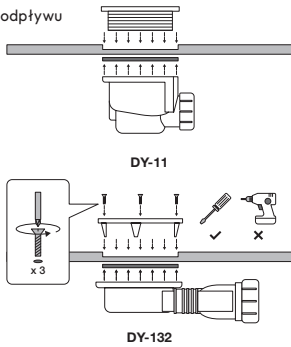

DY-11

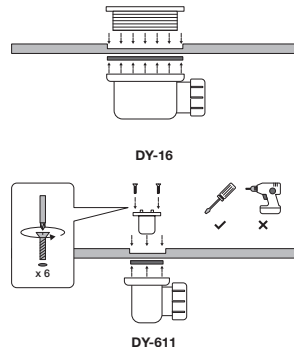

DY-16

3.2

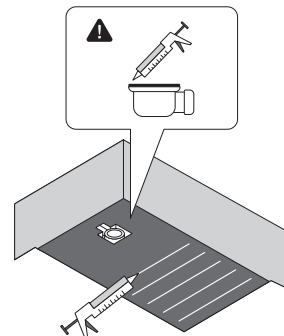

Aby zainstalować odpływ, dla bezpieczeństwa, nałóż kordon silikonowego uszczelniacza.

Po wszystkich kontrolach i regulacjach uszczelnij silikonem wzdłuż prostych szczelin.

3.4

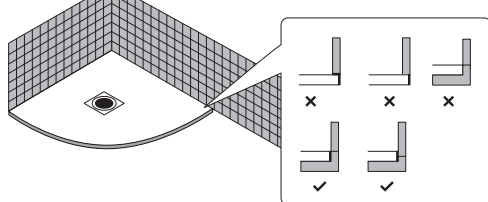

3.5

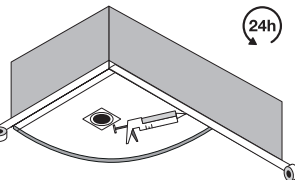

24h

3.6

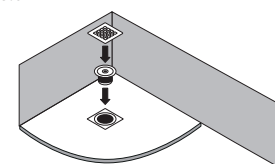

Zabezpiecz brodzik i dokończ montaż kabiny, niezbędne jest pozostawienie szczeliny wypełnionej uszczelniaczem silikonowym 2-3 mm pomiędzy brodzikiem a ścianą, płytkami, panelami lub innym elementem przylegającym. Jeśli musisz położyć płytki na brodziku, upewnij się, że ciężar nie opiera się bezpośrednio na brodziku.

Zabezpiecz brodzik taśmą maskującą przed uszczelnieniem i zainstaluj połączenie brodzika ze ścianami silikonem. Pozostaw do wyschnięcia na 24 godziny.

Wsuń tylko rurę odpływową do syfonu i przykręć centralną śrubę, umieść stalową osłonę w kwadratowym wgłębieniu pośrodku brodzika.

3.7

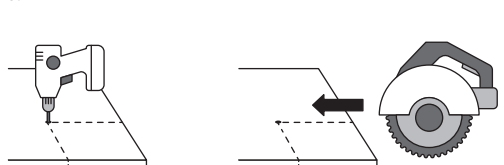

3.8

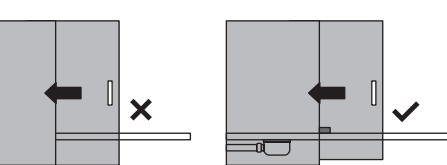

3.9

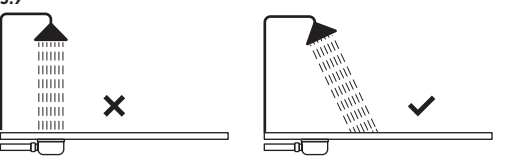

Wywierć otwór w punkcie przecięcia dwóch linii cięcia, użyj tarczy kątowej diamentowej, aby wyciąć od zewnątrz do otworu, dokładnie podążając za linią cięcia.

**OSTRZEŻENIE!** Nigdy nie przesuwaj metalowych profilianiszkałtą brodziku, aby nie zarysować brodzika. **OSTRZEŻENIE!** Nie pozwól, aby podczas montażu kabiny na brodziku spadły resztki silikonu.

Wskazane jest, aby tryskająca woda z prysznica nie spływała bezpośrednio na pokrywe, ponieważ może to drastycznie zmniejszyć wydajność odpływu brodzika.

### 4. CZYSZCZENIE

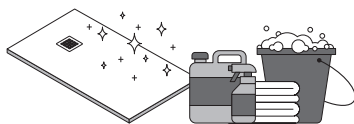
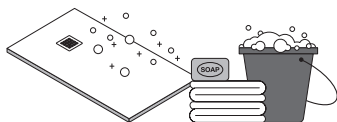

#### 4.1

##### Dla rutynowego czyszczenia:

Czyszcz brodzik mydłem i wodą, wspomagając czyszczenie miękkim materiałem lub ściereczką do czyszczenia. Nie używaj nigdy gąbki do szorowania. Ponieważ jest to podstawowe czyszczenie, zaleca się jego wykonywanie codziennie.

##### Dla dokładnego czyszczenia:

Możesz użyć dowolnego komercyjnego środka czyszczącego, w tym najsilniejszego, ale zawsze wyczyść go po pozostawieniu produktu na kilka minut. Bardzo ważne jest, aby nie pozostawiać go na brodziku godzinami, ponieważ może to spowodować niepożądane plamy. W tym procesie możesz użyć ściereczki lub ściereczki do czyszczenia, ale nigdy nie używaj gąbki do szorowania.

##### Posprzątaj po pracy:

Do czyszczenia sugerujemy użycie mydła lub podobnego środka. **NIGDY NIE UŻYWAĆ SZCZOTKI ZE STALI NIERDZEWNEJ (SZKOCKIEJ LUB PODOBNEJ)**, ani rozpuszczalników, kwasów ani produktów ściernych. Używaj rękawiczek, maski ochronnej i okularów.

#### 4.2

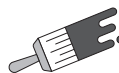

Produkt do farbowania włosów: Jeśli spłuczysz natychmiast, brodzik nie zostanie naruszony. W przypadku, gdy barwnik pozostanie na brodziku na kilka minut przez nieuwagę zostawi plamy. Plamy te usuniemy za pomocą mycia ręcznego.

Plamy silikonu lub podobnego: Aby usunąć tego rodzaju plamy, użyj kawałka drewna ostrożnie pocierając, aż plama zniknie. Są łatwiejsze do usunięcia, jeśli czyszczysz kwasem cytrynowym lub alkoholem.

Plamy z robót: Plamy cementu, tynku itp.: W takim przypadku wskazane jest użycie kwasu solnego. Pozostaw do działania na 2-3 minuty na plamę, a następnie spłucz wodą. Proces można powtórzyć kilka razy.

Plamy z farby: Trudniejsze do usunięcia. Najlepszym rozwiązaniem jest przeszlifowanie dotkniętego obszaru i ponowne pomalowanie go zestawem naprawczym.

Wapno: plamy wapienne na wszystkich ciemnych kolorach brodzika mogą stanowić problem w niektórych obszarach geograficznych. Aby go usunąć, możesz użyć dowolnego komercyjnego środka do usuwania kamienia lub żelu toaletowego do usuwania kamienia z kwasem solnym. Usuń kratkę nierdzewną przed czyszczeniem tego rodzaju produktem chemicznym (jeśli jest zainstalowana).

### 5. UTRZYMANIE

#### 5.1



Żel pokrywający (200 ml)



Utwardzacz (15ml)



Blok pianowy



Papier ścierny (320µm)



Płytkę do skrobania



Niestrzepiąca się ściereczka



Skrobak

#### 5.2

1

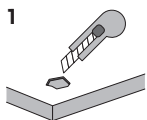

1. Za pomocą skrobaka zeskrób żel pokrywający z uszkodzonego obszaru.

2

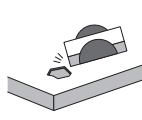

2. Użyj papieru ściernego, aby owinąć blok pianowy, a następnie przeszlifuj obszar z wodą.

3

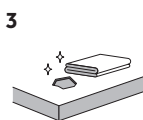

3. Nałóż aceton lub alkohol etylowy z wodą za pomocą niestrzepiącej się ściereczki. Bardzo dobrze wyczyść powierzchnię brodzika, powierzchnia musi być całkowicie czysta i sucha.

4

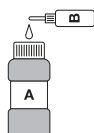

4. Przygotuj naprawczy żel pokrywający i utwardzacz w następujących proporcjach (żel pokrywający: utwardzacz = 25 : 1).

5

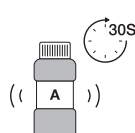

5. Następnie potrząśnij przez 30 sekund.

6

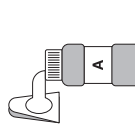

6. Weź trochę naprawczego żelu pokrywającego za pomocą płytki do zdrapywania.

7

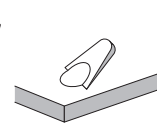

7. Napraw zepsute miejsce do uzyskania płaskości.

#### 5.3

8

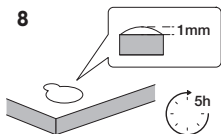

8. Na koniec pozostaw do wyschnięcia na 5 godzin.

9

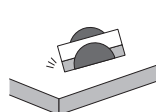

9. Ponownie przeszlifuj obszar papierem ściernym, zachowaj powierzchnię tekstury.

10

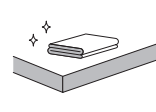

10. Następnie wyczyść powierzchnię suchą, niestrzepiącą się ściereczką, po czym nanieś aceton lub alkohol etylowy w wodzie za pomocą niestrzepiącej się ściereczki.

### 6. WSKAZÓWKI

- Brodzik transportować tylko w opakowaniu, unikać nadmiernych obciążeń.
- Nie umieszczać w pozycji pionowej.
- Nie odpowiadamy za szkody spowodowane niewłaściwym przechowywaniem lub transportem.
- Instalacja musi być wykonana wyłącznie przez autoryzowanego specjalistę.
- Zawsze sprawdzaj przed zamontowaniem brodzika
- Podczas montażu brodzika należy zawsze chronić powierzchnię brodzika, kafelki, płytki ściennie.
- Aby zainstalować odpływ, należy postępować zgodnie z instrukcjami producenta.
- Unikaj wszelkiego rodzaju zabrudzeń, w tym pozostawionych na odpadach.
- Ściany, na których znajduje się wymienny panel, muszą być czyste, suche i odtłuszczone.
- W celu zapewnienia prawidłowego montażu etapy prac muszą być wykonane w odpowiedniej kolejności.

### WARUNKI GWARANCJI

- Okres: gwarancji:**  
Gwarancja obowiązuje przez 5 lat od daty zakupu.
- Zakres: gwarancji:**  
Obejmuje wady materiałowe i produkcyjne ujawnione podczas użytkowania zgodnego z przeznaczeniem.
- Wyłączenia z gwarancji:**
  - Uszkodzenia mechaniczne spowodowane niewłaściwym użytkowaniem, transportem lub montażem.
  - Uszkodzenia powstałe w wyniku stosowania agresywnych środków chemicznych lub niewłaściwej pielęgnacji.
  - Naturalne zużycie produktu (np. drobne zarzysowania, przebarwienia).
- Warunki utrzymania gwarancji:**
  - Sprawdzenie produktu przed montażem pod kątem ewentualnych wad fabrycznych i właściwego wyprofilowania spadku.
  - Montaż musi zostać wykonany zgodnie z instrukcją producenta.
  - Produkt należy pielęgnować wyłącznie zalecanymi środkami czystości.
- Procedura reklamacyjna:**
  - W przypadku ujawnienia wady należy zgłosić reklamację w miejscu zakupu, przedstawiając dowód zakupu oraz opis usterki.
  - Producent zastrzega sobie prawo do naprawy, wymiany produktu lub zwrotu pieniędzy.
- Kontakt:**  
Wszelkie pytania lub zgłoszenia prosimy kierować na adres producenta



**BALNEO POLSKA**  
tel: +48 22 740 72 74, +48 737 923 005, +48 799 787 334,  
e-mail: [biuro@balneo.pl](mailto:biuro@balneo.pl)  
more information on: [www.balneo.pl](http://www.balneo.pl)



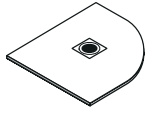

## SHOWER TRAY INSTALLATION

1. Initial verification
2. Substrate preparation
3. Shower tray installation
4. Cleaning
5. Maintenance
6. Tips



**Necessary tools:**  
 Measuring tape, Painter's tape, Adhesive mortar, Adhesive mortar, Bucket, Gloves, Silicone sealant dispenser, Spirit level, Screwdriver, Pencil, Trowel



## 1. INITIAL VERIFICATION

1.1 Check if the shower tray appears deformed or has any dents or scratches. Verify that the model, color, and texture are correct. After installation, exchanges or complaints for the above-mentioned reasons will not be accepted.

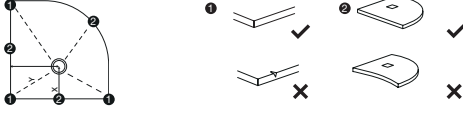

1.2

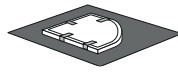

The shower tray must be stored in a horizontal position, ensuring that it is not scratched by screws or the cover.

1.3



1.4

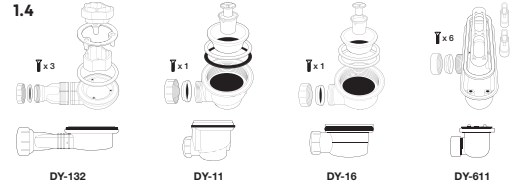

Carefully check all parts of the drainage valve received.

## 2. SURFACE PREPARATION

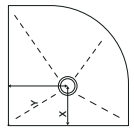

2.1 To install, the drain must align with the center of the shower tray's outlet.

2.4

A solid, non-deformed, and perfectly leveled base must be achieved using cement material. Ensure that the opening around the valve is not higher than 2 cm or lower than the base level.

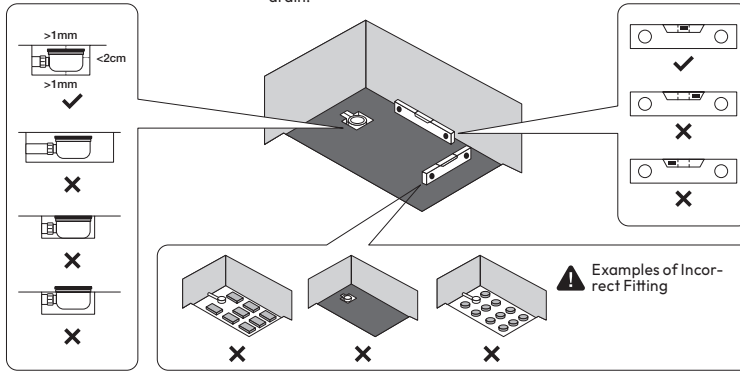

2.2

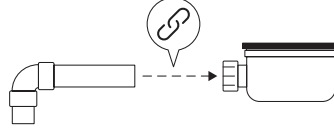

Check the connection between the drain and the drainage pipe. Ensure that there are no leaks at the bathtub joint by pouring water into the drain.

2.3

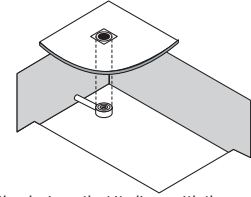

Install the drain so that it aligns with the center of the shower tray's outlet.

## 3. SHOWER TRAY INSTALLATION

Before applying adhesive and continuing with the installation, place the shower tray on the base and connect the drain. Pour plenty of water and check if it flows directly into the outlet. This verification is crucial; we do not accept any complaints, exchanges, or refunds after the shower tray has been installed.

3.1

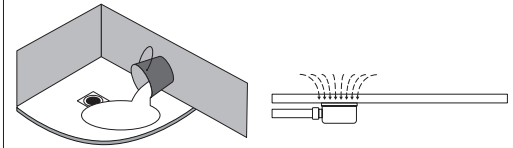

3.2 Drain Installation

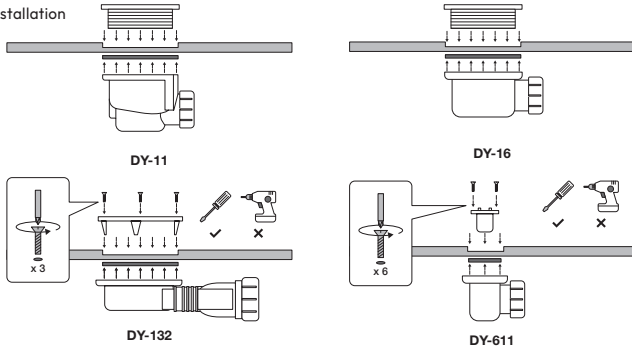

3.2

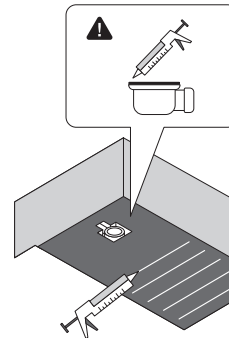

To install the drain, for safety, apply a bead of silicone sealant. After all checks and adjustments, seal with silicone along the straight seams.

3.4

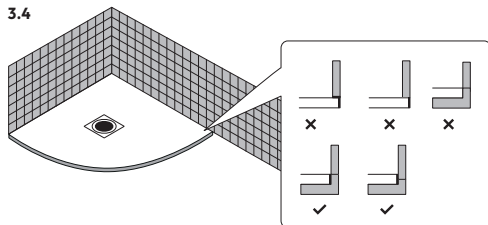

3.5

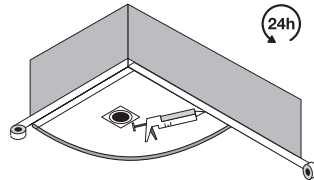

3.6

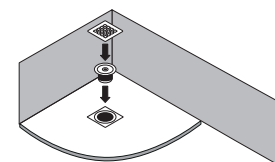

Secure the shower tray and complete the cabin installation. It is essential to leave a 2-3 mm gap filled with silicone sealant between the shower tray and the wall, tiles, panels, or any other adjoining elements. If files need to be installed on the shower tray, ensure that the weight does not rest directly on the tray.

Protect the shower tray with masking tape before sealing, and insulate the connection between the shower tray and the walls with silicone. Leave it to dry for 24 hours.

Insert only the drain pipe into the siphon, tighten the central screw, and place the steel cover in the square recess in the center of the shower tray.

3.7

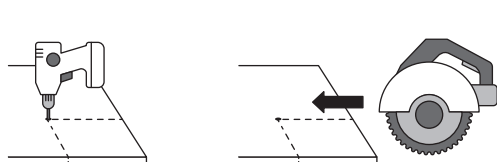

Drill a hole at the intersection of two cutting lines. Use a diamond angle grinder blade to cut from the outside to the hole, precisely following the cutting line.

3.8

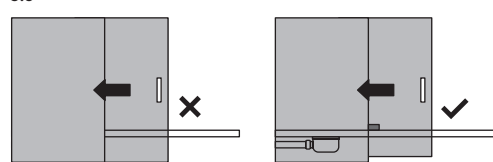

WARNING! Never move metal profiles or glass over the shower tray to avoid scratching it. WARNING! Avoid dropping silicone residues on the shower tray during cabin installation.

3.9

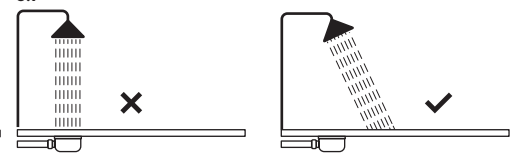

It is recommended that the shower water does not flow directly onto the cover, as this may significantly reduce the efficiency of the shower tray drain.

#### 4. CLEANING

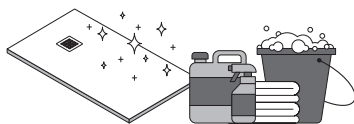
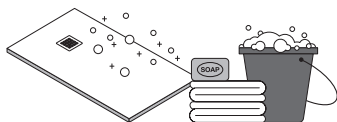

##### 4.1

###### For Routine Cleaning:

Clean the shower tray with soap and water, assisting the process with a soft material or cleaning cloth. Never use a scrubbing sponge. Since this is basic cleaning, it is recommended to do it daily.

###### For Thorough Cleaning:

You can use any commercial cleaner, including the strongest ones, but always rinse it off after leaving the product on for a few minutes. It is very important not to leave it on the shower tray for hours, as this can cause unwanted stains. During this process, you can use a cloth or cleaning rag, but never a scrubbing sponge.

###### Post-Cleaning:

For cleaning, we suggest using soap or a similar product. **NEVER USE STAINLESS STEEL BRUSHES (SUCH AS SCOTCH-BRITE)** or solvents, acids, or abrasive products. Use gloves, a protective mask, and goggles.

##### 4.2



###### Hair Dye Products:

If rinsed immediately, the shower tray will remain unaffected. However, if the dye is left on the shower tray for several minutes by accident, it will leave stains. These stains can be removed with manual cleaning.



###### Silicone or Similar Stains:

To remove these stains, use a piece of wood and carefully rub until the stain disappears. They are easier to remove if cleaned with citric acid or alcohol.



###### Construction Stains:

Cement, plaster, or similar stains: In such cases, it is recommended to use hydrochloric acid. Leave it on the stain for 2-3 minutes, then rinse with water. This process can be repeated several times.

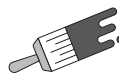

###### Paint Stains:

1. These are harder to remove. The best solution is to sand the affected area and repaint it with a repair kit.



###### Lime Scale:

Lime scale stains on all dark-colored shower trays can be problematic in some geographic areas. To remove them, you can use any commercial descaler or toilet gel with hydrochloric acid. Remove the stainless-steel grid before cleaning with this type of chemical product (if installed).

#### 5. MAINTENANCE

##### 5.1



Covering Gel (200 ml)



Hardener (15 ml)



Foam Block



Sandpaper (320 µm)



Scraping Plate



Linden Cloth



Scraper

##### 5.2

1

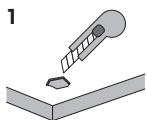

1. Scrape off the gel coating from the damaged area using a scraper.

2

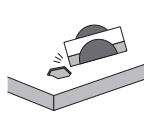

2. Wrap sandpaper around a foam block and sand the damaged area.

3

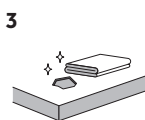

3. Apply acetone or ethyl alcohol mixed with water using a lint-free cloth. Thoroughly clean the shower tray surface, ensuring it is completely clean and dry.

4

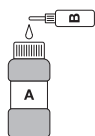

4. Prepare the repair gel coating and hardener in the following proportions (gel coating: hardener = 25:1).

5

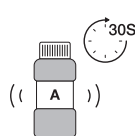

5. Shake for 30 seconds.

6

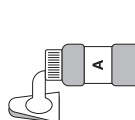

5. Take some repair gel coating using a scraping plate.

7

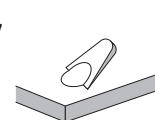

6. Fix the damaged area to achieve flatness.

##### 5.3

8

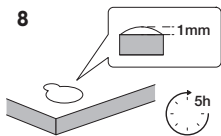

7. Let it dry for 5 hours.

9

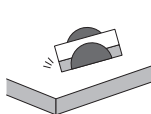

8. Resand the area with sandpaper, maintaining the texture of the surface.

10

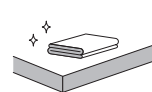

9. Finally, clean the surface with a dry, lint-free cloth, then apply acetone or ethyl alcohol mixed with water using a lint-free cloth.

#### 6. TIPS

- Transport the shower tray only in its packaging, avoid excessive loads.
- Do not place it in a vertical position.
- We are not liable for damage caused by improper storage or transport.
- The installation must only be carried out by an authorised specialist.
- Always check before installing the shower tray
- When installing the shower tray, always protect the surfaces of the shower tray, tiles, wall tiles.
- To install the drain, follow the manufacturer's instructions.
- Avoid any type of dirt, including leftovers.
- The walls on which the removable panel is located must be clean, dry and degreased.
- To ensure correct installation, the work steps must be carried out in the correct order.

#### WARRANTY CONDITIONS

- Warranty period:**  
The warranty is valid for 5 years from the date of purchase.
- Warranty scope:**  
Covers material and manufacturing defects disclosed during use in accordance with the intended purpose.
- Warranty exclusions:**
  - Mechanical damage caused by improper use, transport or installation.
  - Damage resulting from the use of aggressive chemical agents or improper care.
  - Natural wear and tear of the product (e.g., minor scratches, discoloration).
- Conditions for maintaining the warranty:**
  - Check the product for any factory defects and proper slope profiling before installation.
  - Installation must be carried out in accordance with the manufacturer's instructions.
  - The product should be cared for using only recommended cleaning agents.
- Complaint procedure:**
  - In the event of a defect, a complaint should be filed at the place of purchase, presenting proof of purchase and a description of the defect.
  - The manufacturer reserves the right to repair, replace the product, or refund the money.
- Contact:**  
All questions or submissions should be directed to the manufacturer's address.



**BALNEO POLSKA**  
tel: +48 22 740 72 74, +48 737 923 005, +48 799 787 334,  
e-mail: [biuro@balneo.pl](mailto:biuro@balneo.pl)  
more information on: [www.balneo.pl](http://www.balneo.pl)



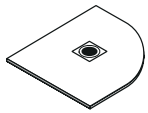

## SHOWER TRAY INSTALLATION

1. Initial verification
2. Substrate preparation
3. Shower tray installation
4. Cleaning
5. Maintenance
6. Tips



Notwendige Werkzeuge:  
Maßband, Malerband, Mörtel, Klebmörtel, Eimer, Handschuhe, Spender mit Silikonabdichtmittel, Wasserwaage, Schraubendreher, Bleistift, Kelle



## 1. ANFANGSPRÜFUNG

1.1 Überprüfen Sie, ob die Duschwanne nicht verzogen aussieht und keine Beulen oder Kratzer aufweist. Überprüfen Sie, ob Modell, Farbe und Textur korrekt sind. Nach der Installation sind weder Austausch noch Reklamationen aus den oben genannten Gründen möglich.

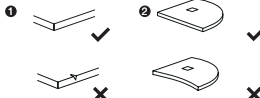
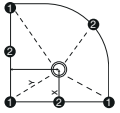

### 1.2

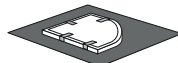

Die Duschwanne sollte in horizontaler Position gelagert werden, wobei darauf zu achten ist, dass sie nicht durch Schrauben oder Abdeckungen zerkratzt wird.

### 1.3



### 1.4

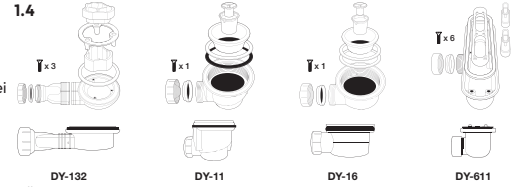

Überprüfen Sie alle Teile des Ablassventils, die Sie erhalten haben, sorgfältig.

## 2. VORBEREITUNG DES UNTERGRUNDS:

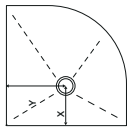

2.1 Für die Montage muss der Ablauf mit der Mitte des Ablaufs der Duschwanne übereinstimmen.

### 2.4

2.4M Sorgen Sie für eine feste, solide Basis, die nicht verzogen und vollständig mit Zementmaterial ausgeglichen ist. Stellen Sie sicher, dass die Öffnung um das Ventil herum nicht mehr als 2 cm höher und nicht unter dem Niveau der Basis liegt.

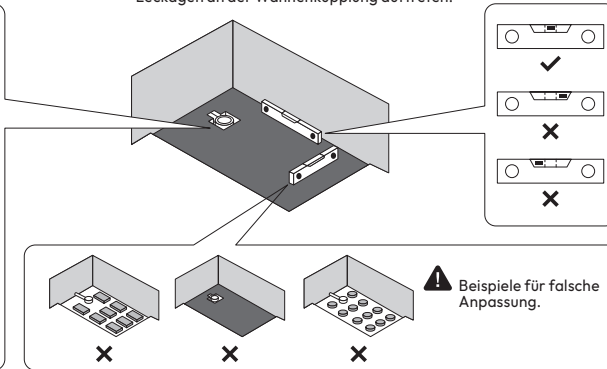
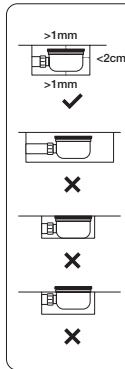

### 2.2

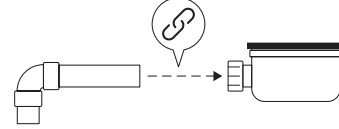

Überprüfen Sie die Verbindung zwischen Ablauf und Abflussrohr und stellen Sie sicher, dass beim Eingießen von Wasser in den Ablauf keine Leckagen an der Wannenkupplung auftreten.

### 2.3

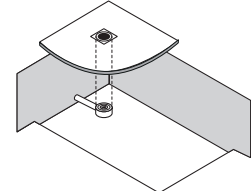

Installieren Sie den Ablauf so, dass er mit der Mitte des Duschwanneablaufs übereinstimmt.

## 3. MONTAGE DER DUSCHWANNE:

Vor dem Auftragen des Klebers und der Fortsetzung der Montage muss die Duschwanne auf die Basis gelegt und der Ablauf angeschlossen werden. Gießen Sie reichlich Wasser ein. Überprüfen Sie, ob das Wasser direkt in den Ablauf fließt. Diese Überprüfung ist sehr wichtig. Nach der Installation der Duschwanne akzeptieren wir keine Reklamationen, Umtausch oder Kostenerstattungen.

### 3.1

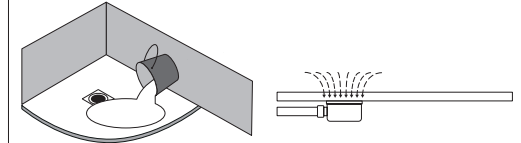

### 3.2 Montage des Ablaufs:

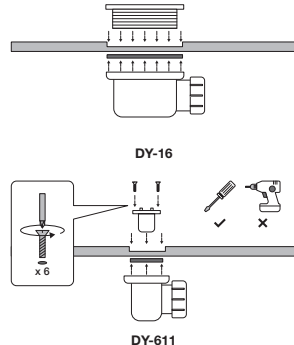
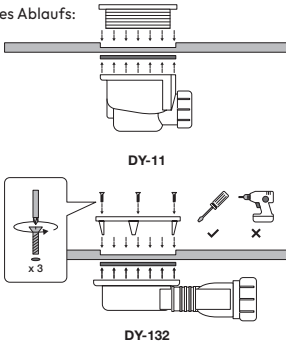

### 3.2

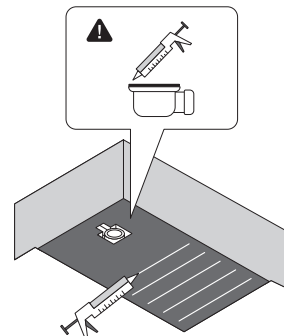

Um den Ablauf zu installieren, tragen Sie aus Sicherheitsgründen eine Silikonabdichtungsmasse auf.

Nach allen Kontrollen und Anpassungen versiegeln Sie die geraden Fugen mit Silikon.

### 3.4

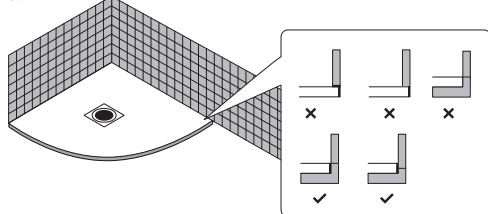

### 3.5

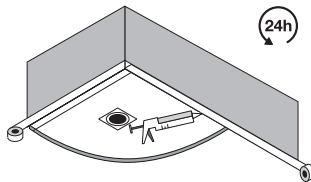

### 3.6

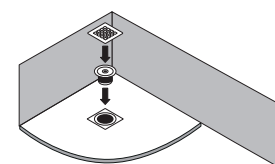

Sichern Sie die Duschwanne und schließen Sie die Montage der Duschkabine ab. Es ist notwendig, eine mit Silikon abgedichtete Lücke von 2-3 mm zwischen der Duschwanne und der Wand, den Fliesen, Paneelen oder anderen angrenzenden Elementen zu lassen. Wenn Sie Fliesen auf der Duschwanne verlegen müssen, achten Sie darauf, dass das Gewicht nicht direkt auf der Wanne liegt.

Schützen Sie die Duschwanne vor dem Versiegeln mit Abdeckband und isolieren Sie die Verbindung zwischen Duschwanne und Wänden mit Silikon. Lassen Sie es 24 Stunden trocknen.

Stecken Sie nur das Abflussrohr in den Siphon, ziehen Sie die zentrale Schraube fest und setzen Sie die Edelstahlabdeckung in die quadratische Vertiefung in der Mitte der Duschwanne ein.

### 3.7

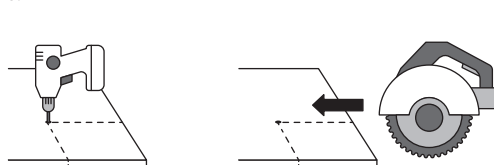

Bohren Sie ein Loch an der Kreuzung der beiden Schnittlinien. Verwenden Sie eine Diamant-Trennscheibe, um von außen zur Bohrung zu schneiden, und folgen Sie dabei genau der Schnittlinie.

### 3.8

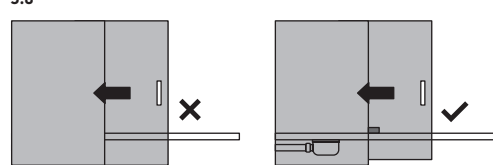

**WARNUNG!** Schieben Sie niemals Metallprofile oder Glas auf der Duschwanne, um Kratzer zu vermeiden.  
**WARNUNG!** Vermeiden Sie, dass Silikonreste während der Montage der Kabine auf die Duschwanne fallen.

### 3.9

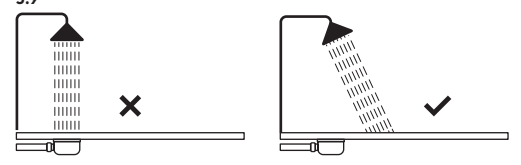

Es wird empfohlen, dass das spritzende Wasser aus der Dusche nicht direkt auf die Abdeckung fällt, da dies die Ablaufleistung der Duschwanne erheblich beeinträchtigen kann.



### 4. REINIGUNG

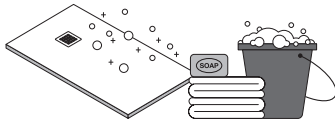

4.1

#### Für die regelmäßige Reinigung:

Reinigen Sie die Duschwanne mit Seife und Wasser und unterstützen Sie die Reinigung mit einem weichen Material oder Reinigungstuch. Verwenden Sie niemals einen Scheuerschwamm. Da dies eine grundlegende Reinigung ist, wird empfohlen, sie täglich durchzuführen.

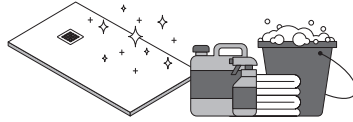

#### Für die gründliche Reinigung:

Sie können jedes handelsübliche Reinigungsmittel verwenden, auch das stärkste, aber spülen Sie es immer nach ein paar Minuten ab. Es ist sehr wichtig, das Reinigungsmittel nicht stundenlang auf der Duschwanne zu lassen, da dies unerwünschte Flecken verursachen kann. Für diesen Prozess können Sie ein Tuch verwenden, aber niemals einen Scheuerschwamm.



#### Nach der Reinigung:

Für die Reinigung empfehlen wir die Verwendung von Seife oder ähnlichem.

**VERWENDEN SIE NIEMALS einen Edelstahlbürsten (wie Scotch-Brite) oder Lösungsmittel, Säuren oder scheuernde Produkte.** Tragen Sie Handschuhe, eine Schutzmaske und eine Schutzbrille.

4.2



**Farbflecken:** Entfernen Sie solche Flecken durch manuelles Scrubben.



**Silikonflecken:** Verwenden Sie ein Stück Holz, um vorsichtig zu reiben, bis der Fleck verschwindet. Diese Flecken lassen sich leichter entfernen, wenn Sie sie mit Zitronensäure oder Alkohol reinigen.



**Bauverschmutzungen (Zement, Gips etc.):** Verwenden Sie Salzsäure. Lassen Sie sie 2-3 Minuten einwirken und spülen Sie sie dann mit Wasser ab. Wiederholen Sie den Vorgang bei Bedarf mehrmals.

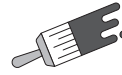

**Farbflecken:** Schwieriger zu entfernen. Die beste Lösung besteht darin, die betroffene Stelle abzuschleifen und mit einem Reparaturset neu zu streichen.



**Kalk:** Kalkflecken auf allen dunklen Duschwannefarben können in manchen geografischen Gebieten ein Problem darstellen. Zum Entfernen können Sie handelsübliche Entkalkungsmittel oder Toilettengel-Entkalker mit Salzsäure verwenden. Entfernen Sie das Edelmetallgitter, bevor Sie es mit einem solchen chemischen Produkt reinigen (falls installiert).

### 5. WARTUNG:

5.1



Abdeckgel (200 ml)



Härter (15 ml)



Schaumstoffblock



Schleifpapier (320µm)



Kratzplatte



Fusselfreies Tuch



Schaber

5.2

1

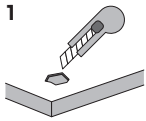

Mit einem Schaber das Abdeckgel von der beschädigten Stelle abkratzen.

2

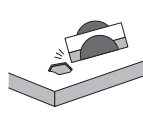

Wickeln Sie den Schaumstoffblock mit Schleifpapier ein und schleifen Sie dann die fehlerhafte Stelle ab.

3

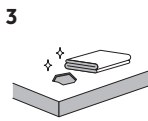

Tragen Sie Aceton oder Ethylalkohol mit Wasser und einem fusselfreien Tuch auf. Reinigen Sie die Oberfläche der Duschwanne sehr gut, die Oberfläche muss absolut sauber und trocken sein.

4

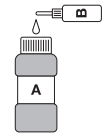

Bereiten Sie Reparatur-Deckgel und Härter im folgenden Verhältnis vor (Deckgel:Härter = 25:1).

5

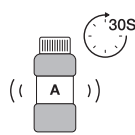

Anschließend 30 Sekunden lang schütteln.

6

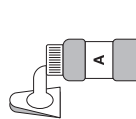

Nehmen Sie etwas Reparatur-Abdeckgel mit dem Kratzpad.

7

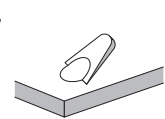

Reparieren Sie die kaputte Stelle, bis sie flach ist.

5.3

8

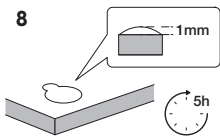

Zum Schluss 5 Stunden trocknen lassen.

9

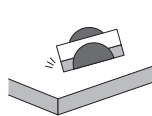

Schleifen Sie die Stelle erneut mit Schleifpapier ab, behalten Sie die strukturierte Oberfläche bei.

10

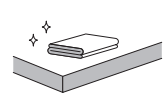

Anschließend die Oberfläche mit einem trockenen, fusselfreien Tuch reinigen und mit einem fusselfreien Tuch Aceton oder Ethylalkohol in Wasser auftragen.

### 6. TIPPS

- Transportieren Sie die Duschwanne nur in der Verpackung, vermeiden Sie übermäßige Belastungen.
- Nicht in vertikaler Position aufstellen.
- Wir haften nicht für Schäden, die durch unsachgemäße Lagerung oder Transport entstehen.
- Die Installation darf nur von einem autorisierten Fachmann durchgeführt werden.
- Überprüfen Sie immer, bevor Sie die Duschwanne installieren
- Schützen Sie beim Einbau der Duschwanne stets die Duschwannenoberflächen, Fliesen und Wandfliesen.
- Befolgen Sie zur Installation des Abflusses die Anweisungen des Herstellers.
- Vermeiden Sie alle Arten von Schmutz, auch den, der im Abfall zurückbleibt.
- Die Wände mit der abnehmbaren Platte müssen sauber, trocken und entfettet sein.
- Um eine ordnungsgemäße Installation zu gewährleisten, müssen die Arbeitsschritte in der richtigen Reihenfolge durchgeführt werden.

### GARANTIEBEDINGUNGEN

- Garantiezeit:**
- Die Garantie gilt für 5 Jahre ab Kaufdatum.**
- Garantieumfang:**  
Deckt Material- und Herstellungsfehler ab, die bei bestimmungsgemäßem Gebrauch offenkundig werden.
- Garantieausschlüsse:**
  - Mechanische Beschädigungen durch unsachgemäßen Gebrauch, Transport oder Montage.
  - Schäden durch aggressive Chemikalien oder unsachgemäße Pflege.
  - Natürlicher Verschleiß des Produkts (z.B. kleine Kratzer, Verfärbungen).
- Bedingungen für die Aufrechterhaltung der Garantie:**
  - Überprüfung des Produkts auf eventuelle Fabrikationsfehler und korrekte Gefälleprofilierung vor der Montage.
  - Die Installation muss gemäß den Anweisungen des Herstellers erfolgen.
  - Das Produkt sollte nur mit den empfohlenen Reinigungsmitteln gepflegt werden.
- Reklamationsverfahren:**
  - Im Falle eines Mangels sollte eine Reklamation am Kaufort eingereicht werden, wobei der Kaufbeleg und eine Beschreibung des Mangels vorzulegen sind.
  - Der Hersteller behält sich das Recht vor, das Produkt zu reparieren, zu ersetzen oder den Kaufpreis zu erstatten.
- Kontakt:**  
Alle Fragen oder Einsendungen richten Sie bitte an die Adresse des Herstellers.



**BALNEO POLSKA**

tel: +48 22 740 72 74, +48 737 923 005, +48 799 787 334,

e-mail: [biuro@balneo.pl](mailto:biuro@balneo.pl)

more information on: [www.balneo.pl](http://www.balneo.pl)



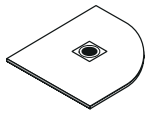

### EINBAU EINER DUSCHWANNE

1. Erste Überprüfung
2. Untergrundvorbereitung
3. Einbau einer Duschwanne
4. Reinigung
5. Wartung
6. Tipps



**Necessary tools:**  
Measuring tape, Painter's tape, Adhesive mortar, Adhesive mortar, Bucket, Gloves, Silicone sealant dispenser, Spirit level, Screwdriver, Pencil, Trowel



## 1. VÉRIFICATION INITIALE

1.1 Vérifiez que le receveur de douche ne semble pas déformé et qu'il ne présente aucun impact ni rayure. Vérifiez également que le modèle, la couleur et la texture sont corrects. Une fois installé, aucun échange ni réclamation ne sera accepté pour les raisons mentionnées ci-dessus.

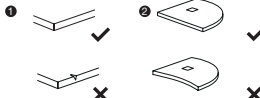
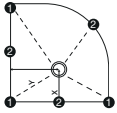

### 1.2

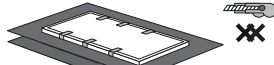

Le receveur de douche doit être stocké en position horizontale, en veillant à ne pas le rayer avec des vis ou une protection.

### 1.3



### 1.4

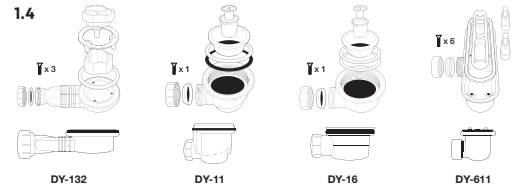

Vérifiez attentivement tous les éléments du siphon que vous avez reçus.

## 2. PRÉPARATION DU SUPPORT

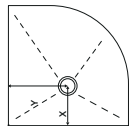

2.1 Pour l'installation, le siphon doit correspondre au centre de l'évacuation du receveur de douche.

### 2.4

Assurez-vous d'avoir une base solide et stable, sans déformation, parfaitement nivelée à l'aide de matériau à base de ciment. Vérifiez que l'ouverture autour de la vanne n'est pas supérieure à 2 cm par rapport au niveau de la base ni en dessous.

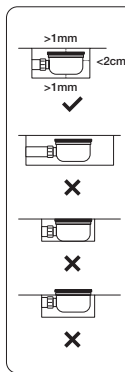

### 2.2

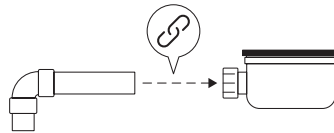

Vérifiez la connexion entre le siphon et le tuyau d'évacuation. Assurez-vous qu'en versant de l'eau dans le siphon, aucune fuite n'apparaît au niveau de la jonction. Installez le siphon de manière à ce qu'il corresponde parfaitement au centre de l'évacuation du receveur.

### 2.3

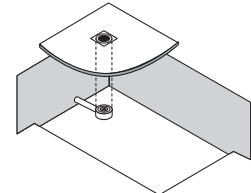

sponde parfaitement au centre de l'évacuation du receveur.

## 3. MONTAGE DU RECEVEUR DE DOUCHE

Avant d'appliquer de la colle et de poursuivre l'installation, placez le receveur sur la base et connectez le siphon. Versez une grande quantité d'eau. Vérifiez que l'eau s'écoule directement vers le siphon. Cette vérification est très importante : aucune réclamation, échange ou remboursement ne sera accepté après l'installation du receveur.

### 3.1

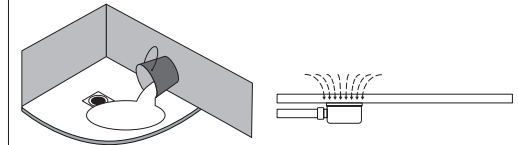

### 3.2 Installation du siphon

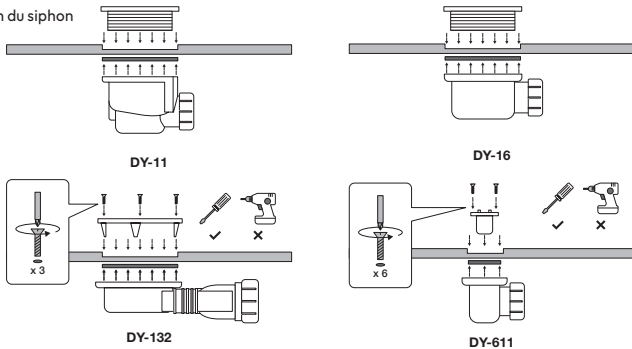

### 3.2

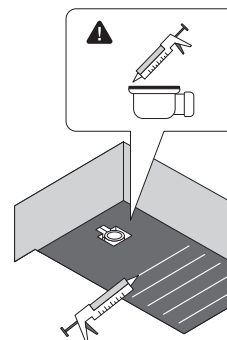

Pour installer le siphon, appliquez un cordon de mastic silicone pour garantir l'étanchéité.

Après toutes les vérifications et ajustements, scellez avec du silicone le long des fissures droites.

### 3.4

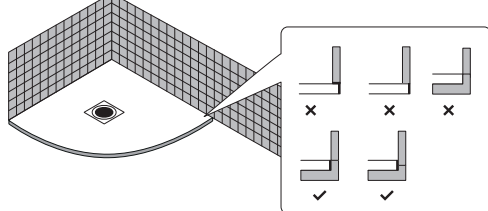

### 3.5

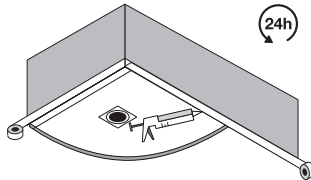

### 3.6

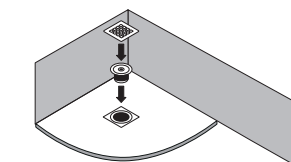

Fixez le receveur de douche et terminez l'installation de la cabine. Il est essentiel de laisser un joint de silicone de 2 à 3 mm entre le receveur et le mur, les carreaux, les panneaux ou tout autre élément adjacent. Si vous devez poser des carreaux sur le receveur, assurez-vous que le poids ne repose pas directement dessus.

Protégez le receveur avec du ruban de masquage avant d'appliquer le silicone et isolez la jonction entre le receveur et les murs avec du silicone. Laissez sécher pendant 24 heures.

Insérez uniquement le tuyau d'évacuation dans le siphon, serrez la vis centrale et placez la protection en acier inoxydable dans l'encoche carrée au centre du receveur.

### 3.7

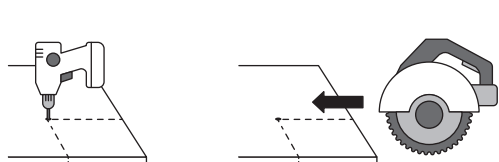

Percez un trou à l'intersection de deux lignes de découpe. Utilisez un disque diamant pour découper de l'extérieur vers le trou, en suivant précisément la ligne de découpe.

### 3.8

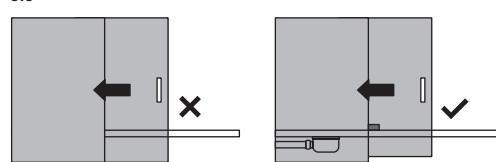

**AVERTISSEMENT!** Ne faites jamais glisser des profilés métalliques ni du verre sur le receveur pour éviter de le rayer.  
**AVERTISSEMENT!** Évitez que des résidus de silicone ne tombent sur le receveur pendant le montage de la cabine.

### 3.9

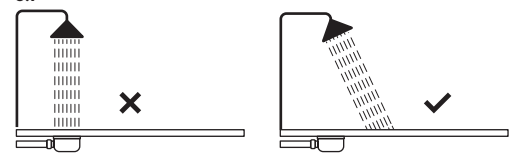

Il est conseillé que l'eau projetée par la douche ne coule pas directement sur la couverture, car cela pourrait réduire considérablement l'efficacité de l'évacuation.



#### 4. NETTOYAGE

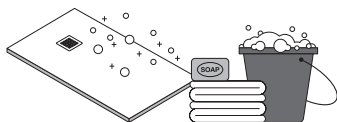

**4.1**  
**Pour un nettoyage quotidien :**  
Nettoyez le receveur avec du savon et de l'eau en utilisant un chiffon doux ou un matériau non abrasif. N'utilisez jamais d'éponges abrasives. Ce nettoyage de base est recommandé quotidiennement.

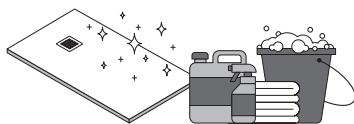

**Pour un nettoyage approfondi :**  
Utilisez tout produit de nettoyage commercial, même les plus puissants, mais rincez bien après avoir laissé agir le produit quelques minutes. Il est très important de ne pas laisser le produit sur le receveur pendant des heures, car cela pourrait provoquer des taches indésirables. Utilisez un chiffon doux, mais jamais d'éponge abrasive.



**Après travaux :**  
Pour nettoyer, nous vous conseillons d'utiliser du savon ou un produit similaire. **N'UTILISEZ JAMAIS** de brosses en acier inoxydable, de solvants, d'acides ou de produits abrasifs. Portez des gants, un masque de protection et des lunettes.

#### 4.2



**Tâches spécifiques :**  
- Teinture capillaire : Si rincée immédiatement, le receveur ne sera pas endommagé. Si la teinture reste sur le receveur quelques minutes par inadvertance, elle laissera des taches, mais celles-ci peuvent être éliminées par un nettoyage manuel.



- Silicone ou similaire : Enlevez ces taches à l'aide d'un morceau de bois en frottant doucement jusqu'à disparition. Le citron ou l'alcool facilitent l'opération.



- Ciment, plâtre, etc. : Utilisez de l'acide chlorhydrique. Laissez agir 2-3 minutes, puis rincez à l'eau. Répétez si nécessaire.

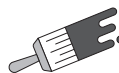

- Peinture : Ces taches sont plus difficiles à enlever. La meilleure solution est de poncer la zone touchée et d'appliquer un kit de réparation.



- Calcaire : Sur les receveurs foncés, le calcaire peut poser problème dans certaines régions. Utilisez un produit anti-calcaire. Retirez la grille inoxydable avant d'utiliser ce produit chimique.

#### 5. ENTRETIEN

##### 5.1



Gel de couverture (200 ml)



Durcisseur (15 ml)



Schaumstoffblock



Schleifpapier (320µm)



Kratzplatte



Fusselfreies Tuch



Schaber

##### 5.2

1

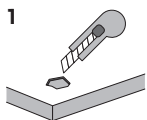

- Utilisez un grattoir pour gratter le gel de revêtement de la zone endommagée.

2

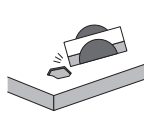

Utilisez du papier de verre pour envelopper le bloc de mousse, puis poncez la zone défectueuse.

3

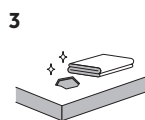

Appliquez de l'acétone ou de l'alcool éthylique avec de l'eau à l'aide d'un chiffon non pelucheux. Nettoyez très bien la surface du receveur de douche, la surface doit être complètement propre et sèche.

4

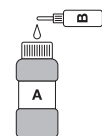

Préparer le gel couvrant de réparation et le durcisseur dans les proportions suivantes (gel couvrant : durcisseur = 25:1).

5

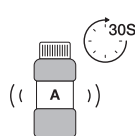

Secouez ensuite pendant 30 secondes.

6

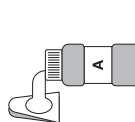

Prélevez un peu de gel de recouvrement réparateur avec le scratch pad.

7

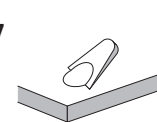

Réparez l'endroit cassé jusqu'à ce qu'il soit plat.

##### 5.3

8

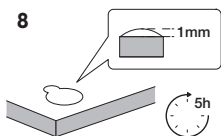

Enfin, laissez sécher 5 heures.

9

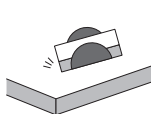

Poncez à nouveau la zone avec du papier de verre, conservez la surface texturée.

10

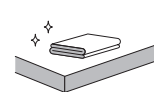

Nettoyez ensuite la surface avec un chiffon sec et non pelucheux et appliquez de l'acétone ou de l'alcool éthylique dans de l'eau avec un chiffon non pelucheux.

#### 6. CONSEILS

- Transporter le receveur de douche uniquement dans son emballage, éviter les charges excessives.
- Ne pas placer en position verticale.
- Nous ne sommes pas responsables des dommages causés par un stockage ou un transport incorrect.
- L'installation doit être effectuée uniquement par un spécialiste agréé.
- Vérifiez toujours avant d'installer le receveur de douche.
- Lors de l'installation du receveur de douche, toujours protéger les surfaces du receveur, des carreaux, des panneaux muraux.
- Pour installer le drain, suivez les instructions du fabricant.
- Évitez tout type de saleté, y compris celle laissée sur les déchets.
- Les murs où se trouve le panneau amovible doivent être propres, secs et dégraissés.
- Pour garantir une installation correcte, les étapes de travail doivent être effectuées dans le bon ordre.

#### CONDITIONS DE GARANTIE

- Période de garantie :**  
La garantie est valable pendant 5 ans à partir de la date d'achat.
- Étendue de la garantie :**  
Couvre les défauts matériels et de fabrication révélés lors d'une utilisation conforme à l'usage prévu.
- Exclusions de garantie :**
  - Dommages mécaniques causés par une utilisation, un transport ou une installation incorrects.
  - Dommages résultant de l'utilisation d'agents chimiques agressifs ou d'un entretien inadéquat.
  - Usure naturelle du produit (par exemple, petites rayures, décoloration).
- Conditions de maintien de la garantie :**
  - Vérifiez le produit avant l'installation pour détecter d'éventuels défauts de fabrication et un profilage correct de la pente.
  - L'installation doit être réalisée conformément aux instructions du fabricant.
  - Le produit doit être entretenu uniquement avec les agents de nettoyage recommandés.
- Procédure de réclamation :**
  - En cas de défaut, une réclamation doit être déposée sur le lieu d'achat, en présentant une preuve d'achat et une description du défaut.
  - Le fabricant se réserve le droit de réparer, remplacer le produit ou rembourser l'argent.
- Contact :**  
Toutes les questions ou soumissions doivent être adressées à l'adresse du fabricant.



**BALNEO POLSKA**  
tel: +48 22 740 72 74, +48 737 923 005, +48 799 787 334,  
e-mail: biuro@balneo.pl  
**more information on: [www.balneo.pl](http://www.balneo.pl)**



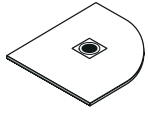

## INSTALLAZIONE DEL PIATTO DOCCIA

1. Verifica iniziale
2. Preparazione del fondo
3. Montaggio del piatto doccia
4. Pulizia
5. Manutenzione
6. Indicazioni



**Necessary tools:**  
Measuring tape, Painter's tape, Adhesive mortar, Adhesive mortar, Bucket, Gloves, Silicone sealant dispenser, Spirit level, Screwdriver, Pencil, Trowel



### 1. VERIFICA INIZIALE

1.1 Controlla che il piatto doccia non sembri deformato e che non ci siano ammaccature o graffi. Verifica che il modello, il colore e la trama siano corretti. Una volta installato, non sono accettate sostituzioni né reclami per i motivi sopra menzionati.

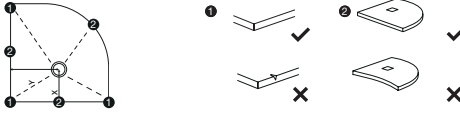

### 1.2

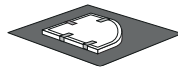

Il piatto doccia deve essere conservato in posizione orizzontale, facendo attenzione a non graffiare il piatto con le viti o la copertura. Installazione di base.

### 1.3



Installazione a livello del

pavimento.

### 1.4

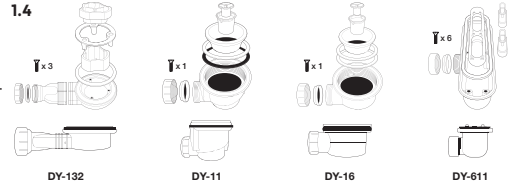

Controlla attentamente tutti gli elementi del sistema di scarico ricevuti.

### 2. Preparazione del fondo.

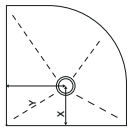

2.1 Per montare, lo scarico deve coincidere con il centro dello scarico del piatto doccia.

### 2.4

È necessario ottenere una base solida e stabile, non deformata e completamente livellata con materiale cementizio. Assicurati che il foro attorno alla valvola non sia più alto di 2 cm e non si trovi sotto il livello della base.

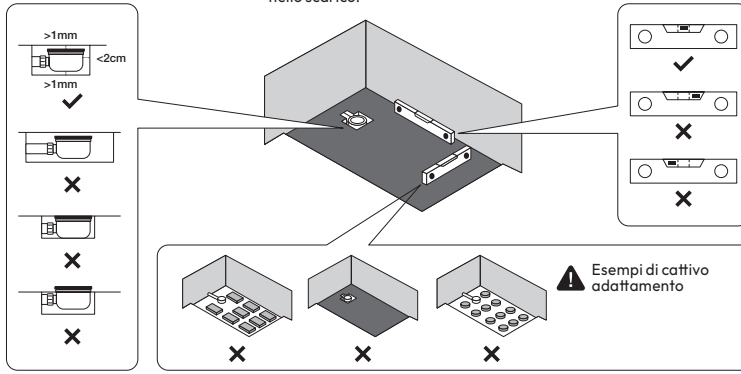

### 2.2

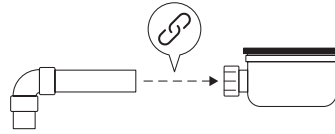

Controlla il collegamento tra lo scarico e il tubo di scarico, assicurati che non ci siano perdite nel collegamento della vasca versando acqua nello scarico.

### 2.3

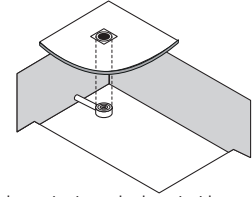

Installa lo scarico in modo che coincida con il centro dello scarico del piatto doccia.

### 3. MONTAGGIO DEL PIATTO DOCCIA.

Prima di applicare la colla e continuare il montaggio, il piatto doccia deve essere posizionato sulla base e collegato allo scarico. Versa abbondante acqua. Controlla che l'acqua defluisca direttamente nello scarico. Questa verifica è molto importante, non accettiamo reclami, sostituzioni o rimborsi una volta installato il piatto doccia.

### 3.1

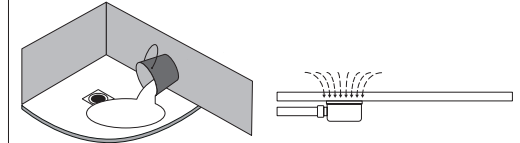

### 3.2 Installazione dello scarico

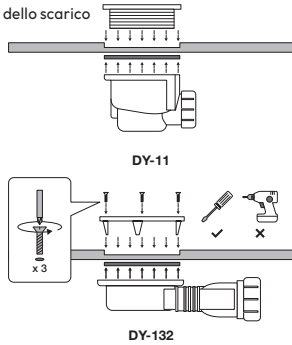

### 3.2

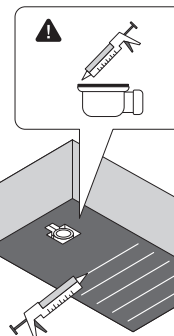
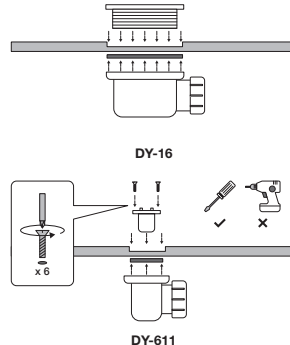

Per installare lo scarico, per sicurezza, applica un cordone di sigillante siliconico.

Dopo tutti i controlli e le regolazioni, sigilla con silicone lungo le fessure dritte.

### 3.4

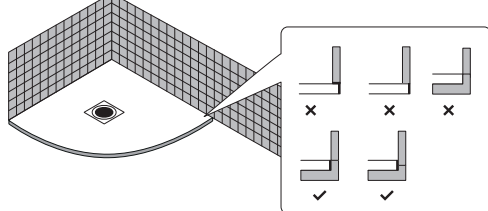

### 3.5

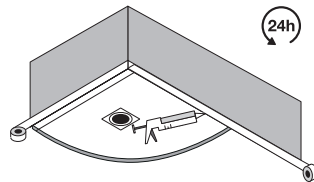

### 3.6

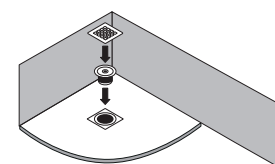

Fissa il piatto doccia e completa l'installazione del box doccia, è necessario lasciare uno spazio di 2-3 mm riempito con sigillante siliconico tra il piatto doccia e il muro, le piastrelle, i pannelli o altri elementi adiacenti. Se devi posare piastrelle sul piatto doccia, assicurati che il peso non si appoggi direttamente sul piatto doccia.

Proteggi il piatto doccia con nastro adesivo prima di sigillare e isola il collegamento del piatto doccia con le pareti con silicone. Lascia asciugare per 24 ore.

Inserisci solo il tubo di scarico nel sifone e avvita la vite centrale, posiziona la copertura in acciaio nell'incavo quadrato al centro del piatto doccia.

### 3.7

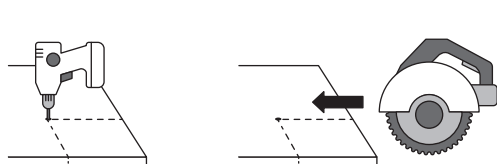

Perforare un foro nel punto di intersezione delle due linee di taglio, utilizzare un disco diamantato angolare per tagliare dall'esterno verso il foro, seguendo esattamente la linea di taglio.

### 3.8

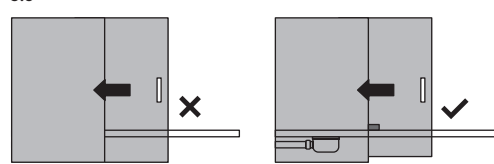

**AVVERTENZA!** Non far scorrere mai i profili metallici o il vetro sul piatto doccia per non graffiarlo.  
**AVVERTENZA!** Non lasciare che cadano residui di silicone sul piatto doccia durante l'installazione del box doccia.

### 3.9

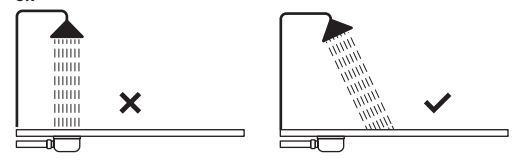

È consigliabile che l'acqua spruzzata dalla doccia non defluisca direttamente sulla copertura, poiché ciò potrebbe ridurre drasticamente l'efficienza dello scarico del piatto doccia.

#### 4. Pulizia

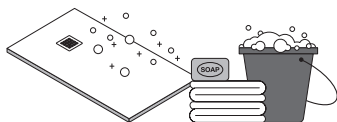

##### 4.1

###### Per la pulizia di routine:

Pulisci il piatto doccia con sapone e acqua, aiutandoti con un panno morbido o un panno per la pulizia. Non usare mai spugne abrasive. Poiché questa è una pulizia di base, si consiglia di eseguirla quotidianamente.

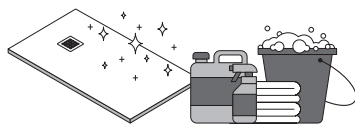

###### Per una pulizia approfondita:

Puoi utilizzare qualsiasi detergente commerciale, anche il più forte, ma puliscilo sempre dopo aver lasciato agire il prodotto per alcuni minuti. È molto importante non lasciarlo sul piatto doccia per ore, poiché potrebbe causare macchie indesiderate. In questo processo puoi usare un panno o un panno per la pulizia, ma mai spugne abrasive.



###### Pulizia dopo il lavoro:

Per la pulizia suggeriamo di utilizzare sapone o un prodotto simile. **NON USARE MAI SPAZZOLE IN ACCIAIO INOX (SCOTCHBRITE O SIMILI), né solventi, acidi o prodotti abrasivi.** Usa guanti, maschera protettiva e occhiali.

##### 4.2



Prodotto per la tintura dei capelli: Se risciacqui immediatamente, il piatto doccia non sarà danneggiato. Nel caso in cui il colorante rimanga sul piatto doccia per alcuni minuti, lascerà macchie. Queste macchie possono essere rimosse con il lavaggio a mano.



Macchie di silicone o simili: Per rimuovere questo tipo di macchie, usa un pezzo di legno sfregandolo delicatamente fino a quando la macchia non scompare. Sono più facili da rimuovere se pulisci con acido citrico o alcol.



Macchie di lavoro: Macchie di cemento, gesso ecc.: In questo caso, si consiglia di utilizzare acido cloridrico. Lascia agire sulla macchia per 2-3 minuti, quindi risciacqua con acqua. Il processo può essere ripetuto più volte.

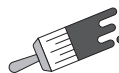

Macchie di vernice: Più difficili da rimuovere. La soluzione migliore è levigare l'area interessata e riverniciare con un kit di riparazione.



Calcare: le macchie di calcare su tutti i colori scuri del piatto doccia possono rappresentare un problema in alcune aree geografiche. Per rimuoverle, puoi utilizzare qualsiasi prodotto commerciale per la rimozione del calcare o un gel per WC contenente acido cloridrico. Rimuovi la griglia in acciaio inossidabile prima di pulire con questo tipo di prodotto chimico (se installata).

### 5. MANUTENZIONE

##### 5.1



Gel di copertura (200 ml)



Indurente (15ml)



Blocco di schiuma



Carta vetrata (320µm)



Piastra per raschiare



Panno non sfilacciato



Raschietto

##### 5.2

1

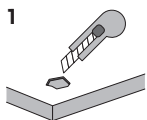

Con uno scrapper, raschia il gel di copertura dall'area danneggiata. Usa carta vetrata per avvolgere un blocco di schiuma, quindi leviga l'area difettosa.

2

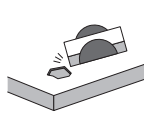

Applica acetone o alcol etilico con acqua usando un panno non sfilacciato.

3

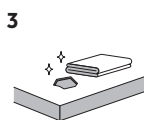

Pulisci molto bene la superficie del piatto doccia, la superficie deve essere completamente pulita e asciutta.

4

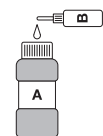

Prepara il gel di copertura di riparazione e l'indurente nelle seguenti proporzioni (gel di copertura: indurente = 25:1).

5

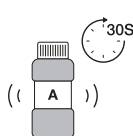

Agita quindi per 30 secondi.

6

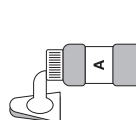

Prendi un po' di gel di copertura di riparazione usando una spatola.

7

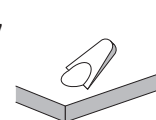

Ripara la parte rotta fino a ottenere la planarità.

##### 5.3

8

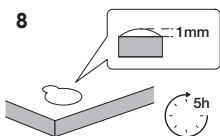

Infine, lascia asciugare per 5 ore.

9

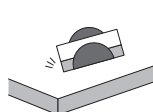

Levigare nuovamente l'area con carta vetrata, mantenendo la consistenza della superficie.

10

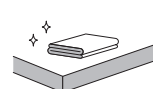

Successivamente, pulire la superficie con un panno asciutto e non sfilacciato, quindi applicare acetone o alcol etilico con acqua utilizzando un panno non sfilacciato.

### 6. INDICAZIONI

1. Trasportare il piatto doccia solo nel suo imballaggio, evitare carichi eccessivi.
2. Non posizionare in verticale.
3. Non siamo responsabili per danni causati da un'errata conservazione o trasporto.
4. L'installazione deve essere eseguita esclusivamente da uno specialista autorizzato.
5. Controlla sempre prima di montare il piatto doccia.
6. Durante l'installazione del piatto doccia è necessario proteggere sempre le superfici del piatto, le piastrelle, le piastrelle murali.
7. Per installare lo scarico, seguire le istruzioni del produttore.
8. Evitare ogni tipo di sporcizia, compresi i residui.
9. Le pareti su cui si trova il pannello rimovibile devono essere pulite, asciutte e sgrassate.
10. Per garantire una corretta installazione, le fasi di lavoro devono essere eseguite nell'ordine corretto.

### CONDIZIONI DI GARANZIA

1. **Periodo di garanzia:**  
La garanzia è valida per 5 anni dalla data di acquisto.
2. **Ambito della garanzia:**  
Copre i difetti di materiali e di fabbricazione riscontrati durante l'uso conforme alla destinazione d'uso.
3. **Esclusioni dalla garanzia:**
  - Danni meccanici causati da uso, trasporto o installazione impropri.
  - Danni derivanti dall'uso di agenti chimici aggressivi o dalla manutenzione impropria.
  - Normale usura del prodotto (ad esempio, piccoli graffi, scolorimenti).
4. **Condizioni per mantenere la garanzia:**
  - Verifica del prodotto per eventuali difetti di fabbricazione e corretta profilatura della pendenza prima dell'installazione.
  - L'installazione deve essere eseguita secondo le istruzioni del produttore.
  - Il prodotto deve essere curato utilizzando solo detersivi raccomandati.
5. **Procedura di reclamo:**
  - In caso di difetto, il reclamo deve essere presentato nel luogo di acquisto, presentando la prova di acquisto e la descrizione del difetto.
  - Il produttore si riserva il diritto di riparare, sostituire il prodotto o rimborsare il denaro.
6. **Contatto:**  
Tutte le domande o segnalazioni devono essere indirizzate all'indirizzo del produttore.



**BALNEO POLSKA**  
tel: +48 22 740 72 74, +48 737 923 005, +48 799 787 334,  
e-mail: biuro@balneo.pl  
more information on: [www.balneo.pl](http://www.balneo.pl)



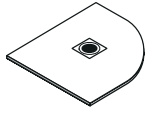

## INSTALACIÓN DEL PLATO DE DUCHA

1. Verificación inicial
2. Preparación del suelo
3. Montaje del plato de ducha
4. Limpieza
5. Mantenimiento
6. Indicaciones



Herramientas necesarias:  
Cinta métrica, Cinta de pintor, Mortero adhesivo, Balde, Guantes, Dispensador con sellador de silicona, Nivel, Destornillador, Lápiz, Paleta



## 1. VERIFICACIÓN INICIAL

1.1 Verifique que el plato de ducha no esté deformado y que no tenga golpes ni arañazos. Verifique que el modelo, el color y la textura sean correctos. Una vez instalado, no se aceptan cambios ni reclamaciones por los motivos mencionados anteriormente.

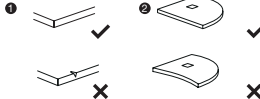
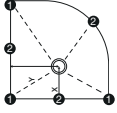

## 1.2

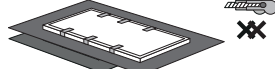

El plato de ducha debe almacenarse en posición horizontal, teniendo cuidado de no rayarlo con tornillos o cubiertas. Instalación básica.

## 1.3



Instalación al nivel del

suelo.

## 1.4

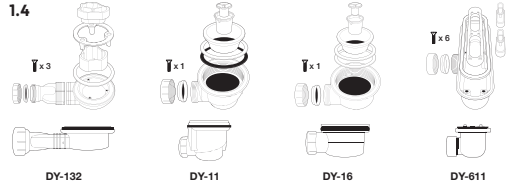

Revise cuidadosamente todos los elementos del desagüe recibidos.

## 2. PREPARACIÓN DEL SUELO.

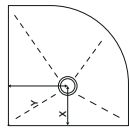

2.1 Para montar, el desagüe debe coincidir con el centro del desagüe del plato de ducha.

## 2.4

Es necesario obtener una base sólida y estable, no deformada y completamente nivelada con material cementoso. Asegúrese de que el agujero alrededor de la válvula no sea más alto de 2 cm y no esté por debajo del nivel de la base.

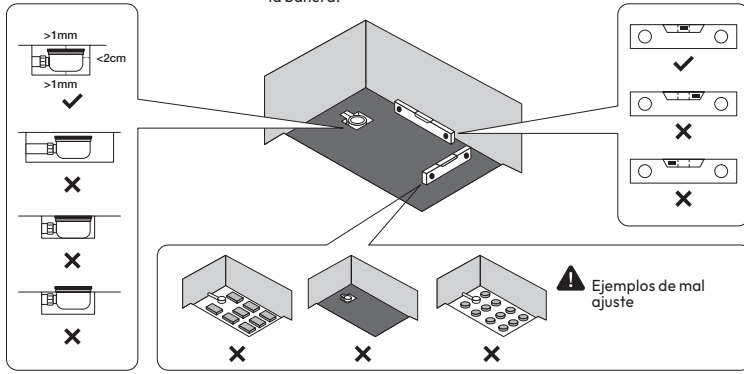

## 2.2

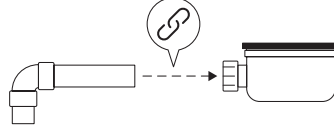

Verifique la conexión entre el desagüe y el tubo de desagüe, asegúrese de que al verter agua en el desagüe no haya fugas en la conexión de la bañera.

## 2.3

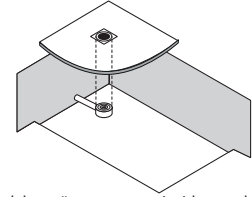

Instale el desagüe para que coincida con el centro del desagüe del plato de ducha.

## 3. MONTAJE DEL PLATO DE DUCHA.

Antes de aplicar el adhesivo y continuar con el montaje, el plato de ducha debe colocarse sobre la base y conectarse al desagüe. Vierta abundante agua. Verifique que el agua fluya directamente al desagüe. Esta verificación es muy importante, no aceptamos reclamaciones, cambios ni reembolsos una vez instalado el plato de ducha.

## 3.1

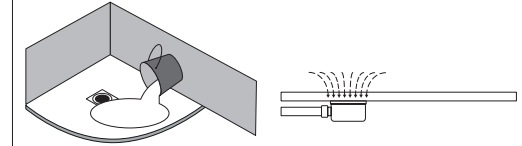

## 3.2 Instalación del desagüe

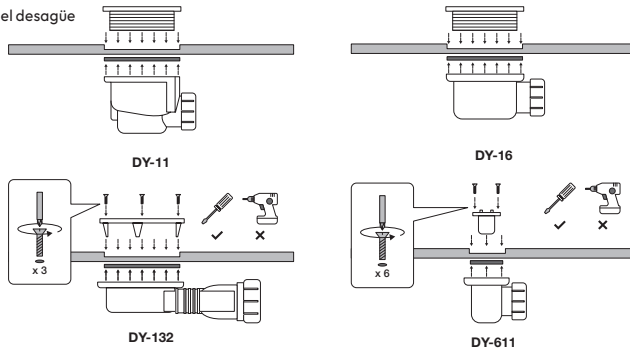

## 3.2

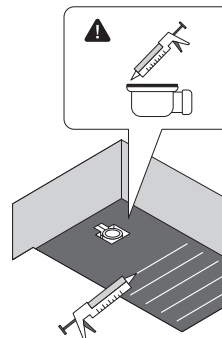

Para instalar el desagüe, por seguridad, aplique un cordón de sellador de silicona.

Después de todas las verificaciones y ajustes, selle con silicona a lo largo de las ranuras rectas.

## 3.4

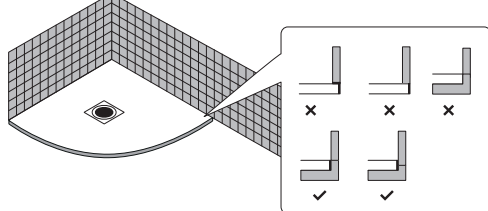

## 3.5

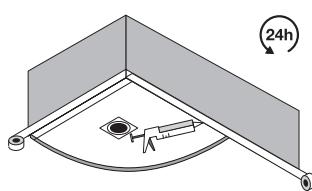

## 3.6

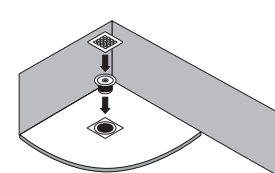

Asegure el plato de ducha y complete la instalación del cabina de ducha, es necesario dejar un espacio de 2-3 mm lleno con sellador de silicona entre el plato de ducha y la pared, las baldosas, los paneles u otro elemento adyacente. Si necesita colocar baldosas en el plato de ducha, asegúrese de que el peso no se apoye directamente en el plato de ducha.

Proteja el plato de ducha con cinta adhesiva antes de sellar e aisle la conexión del plato de ducha con las paredes con silicona. Deje secar durante 24 horas.

Inserte solo el tubo de desagüe en el sifón y atornille el tornillo central, coloque la cubierta de acero en la cavidad cuadrada en el centro del plato de ducha.

## 3.7

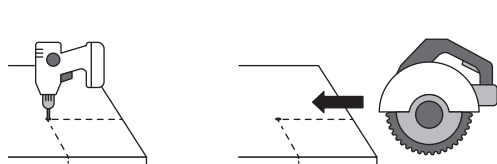

Taladre un agujero en el punto de intersección de las dos líneas de corte, use un disco angular de diamante para cortar desde el exterior hacia el agujero, siguiendo exactamente la línea de corte.

## 3.8

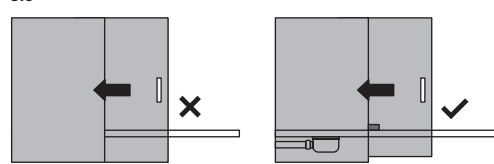

**ADVERTENCIA!** No deslice nunca los perfiles metálicos ni el vidrio sobre el plato de ducha para no rayarlo.  
**ADVERTENCIA!** No deje caer restos de silicona sobre el plato de ducha durante la instalación de la cabina de ducha.

## 3.9

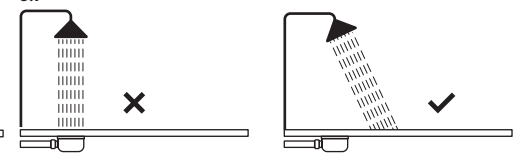

Se recomienda que el agua que salpica de la ducha no fluya directamente sobre la tapa, ya que esto podría reducir drásticamente la eficiencia del desagüe del plato de ducha.

#### 4. LIMPIEZA

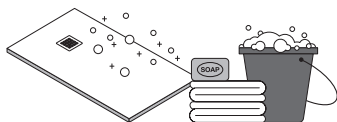

**4.1**  
**Para la limpieza rutinaria:**  
 Limpie el plato de ducha con jabón y agua, ayudándose con un paño suave o un trapo de limpieza. Nunca use esponjas abrasivas. Como esta es una limpieza básica, se recomienda realizarla diariamente.

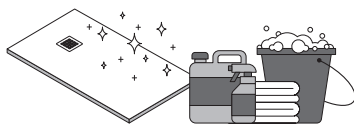

**Para una limpieza a fondo:**  
 Puede usar cualquier limpiador comercial, incluso el más fuerte, pero siempre límpielo después de dejar actuar el producto durante unos minutos. Es muy importante no dejarlo sobre el plato de ducha durante horas, ya que podría causar manchas indeseadas. En este proceso puede usar un trapo o un paño de limpieza, pero nunca esponjas abrasivas.



**Limpieza después del trabajo:**  
 Para la limpieza sugerimos usar jabón o un producto similar. **NUNCA USE CEPILLOS DE ACERO INOXIDABLE (SCOTCHBRITE O SIMILAR), ni disolventes, ácidos ni productos abrasivos.** Use guantes, mascarilla protectora y gafas.

#### 4.2



**Producto para teñir el cabello:** Si enjuaga de inmediato, el plato de ducha no se dañará. En el caso de que el tinte permanezca sobre el plato de ducha durante unos minutos, dejará manchas. Estas manchas se pueden eliminar lavando a mano.



**Manchas de silicona o similar:** Para eliminar este tipo de manchas, use un trozo de madera frotando con cuidado hasta que la mancha desaparezca. Son más fáciles de eliminar si limpia con ácido cítrico o alcohol.



**Manchas de trabajo:** Manchas de cemento, yeso, etc.: En este caso, se recomienda usar ácido clorhídrico. Deje actuar sobre la mancha durante 2-3 minutos, luego enjuague con agua. El proceso se puede repetir varias veces.

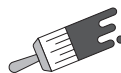

**Manchas de pintura:** Más difíciles de eliminar. La mejor solución es lijar el área afectada y volver a pintar con un kit de reparación.



**Cal:** las manchas de cal en todos los colores oscuros del plato de ducha pueden representar un problema en algunas áreas geográficas. Para eliminarlas, puede usar cualquier producto comercial para eliminar la cal o un gel para inodoro que contenga ácido clorhídrico. Retire la rejilla de acero inoxidable antes de limpiar con este tipo de producto químico (si está instalada).

#### 5. MANTENIMIENTO

##### 5.1



Gel de cobertura (200 ml)



Endurecedor (15 ml)



Bloque de espuma



Papel de lija (320µm)



Placa para raspar



Paño que no suelte pelusa



Raspador

##### 5.2

1

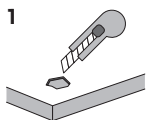

Con un raspador, raspe el gel de cobertura del área dañada. Use papel de lija para envolver un bloque de espuma, luego lije el área defectuosa.

2

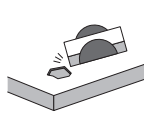

Aplique acetona o alcohol etílico con agua usando un trapo que no suelte pelusa.

3

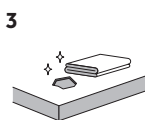

Limpie muy bien la superficie del plato de ducha, la superficie debe estar completamente limpia y seca.

4

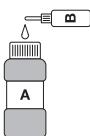

Prepare el gel de cobertura de reparación y el endurecedor en las siguientes proporciones (gel de cobertura: endurecedor = 25:1).

5

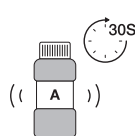

Luego agite durante 30 segundos.

6

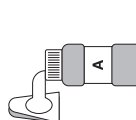

Tome un poco de gel de cobertura de reparación usando una espátula.

7

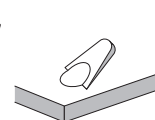

Repare la parte rota hasta obtener planitud.

##### 5.3

8

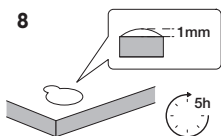

Finalmente, deje secar durante 5 horas.

9

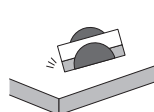

Lije nuevamente el área con papel de lija, manteniendo la textura de la superficie.

10

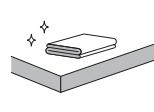

Luego, limpie la superficie con un trapo seco que no suelte pelusa, luego aplique acetona o alcohol etílico con agua usando un trapo que no suelte pelusa.

#### 6. INDICACIONES

- Transportar el plato de ducha solo en su embalaje, evitar cargas excesivas.
- No colocar en posición vertical.
- No nos hacemos responsables por daños causados por almacenamiento o transporte inadecuado.
- La instalación debe ser realizada exclusivamente por un especialista autorizado.
- Revisar siempre antes de montar el plato de ducha.
- Durante la instalación del plato de ducha, proteger siempre las superficies del plato, las baldosas y los azulejos de pared.
- Para instalar el desagüe, seguir las instrucciones del fabricante.
- Evitar todo tipo de suciedad, incluyendo la dejada en los residuos.
- Las paredes donde se encuentra el panel desmontable deben estar limpias, secas y desengrasadas.
- Para asegurar una correcta instalación, los pasos de trabajo deben ser realizados en el orden adecuado.

#### CONDICIONES DE GARANTÍA

- Periodo de garantía:**  
La garantía es válida por 5 años a partir de la fecha de compra.
- Alcance de la garantía:**  
Cubre defectos de materiales y de fabricación revelados durante el uso conforme a su propósito previsto.
- Exclusiones de la garantía:**
  - Daños mecánicos causados por uso, transporte o instalación incorrectos.
  - Daños resultantes del uso de agentes químicos agresivos o del cuidado inadecuado.
  - Desgaste natural del producto (por ejemplo, pequeños arañazos, decoloración).
- Condiciones para mantener la garantía:**
  - Verificación del producto por cualquier defecto de fábrica y correcta profilación de la pendiente antes de la instalación.
  - La instalación debe realizarse de acuerdo con las instrucciones del fabricante.
  - El producto debe ser cuidado utilizando solo los agentes de limpieza recomendados.
- Procedimiento de reclamación:**
  - En caso de defecto, se debe presentar una reclamación en el lugar de compra, presentando el comprobante de compra y una descripción del defecto.
  - El fabricante se reserva el derecho de reparar, reemplazar el producto o devolver el dinero.
- Contacto:**  
Todas las preguntas o envíos deben dirigirse a la dirección del fabricante.



**BALNEO POLSKA**  
 tel: +48 22 740 72 74, +48 737 923 005, +48 799 787 334,  
 e-mail: biuro@balneo.pl  
**more information on: www.balneo.pl**



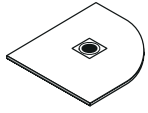

## INSTALLATIE VAN DE DOUCHEBAK

1. Initiële verificatie
2. Voorbereiding van de ondergrond
3. Installatie van de douchebak
4. Schoonmaken
5. Onderhoud
6. Adviezen



Benodigde gereedschappen:  
Meetlint, Schilderstape, Lijmmortel, Emmer, Handschoenen,  
Dispenser met siliconenkit, Waterpas, Schroevendraaier,  
Potlood, Troffel

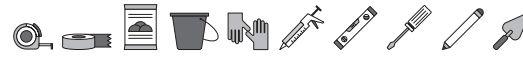

## 1. INITIËLE VERIFICATIE

1.1 Controleer of de douchebak niet vervormd is en geen deuken of krasen heeft. Controleer of het model, de kleur en de textuur correct zijn. Na installatie worden om bovengenoemde redenen geen vervangingen of klachten geaccepteerd.

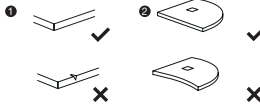
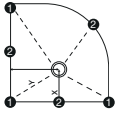

## 1.2

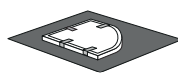

De douchebak dient horizontaal te worden opgeslagen, waarbij ervoor moet worden gezorgd dat de bak niet wordt bekrast door schroeven of afdekking.

## 1.3



Basisinstallatie.



Installatie op vloerniveau.

## 1.4

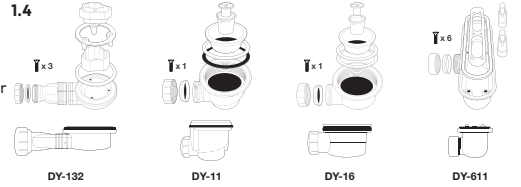

Controleer zorgvuldig alle onderdelen van het afvoerventiel die u hebt ontvangen.

## 2. VOORBEREIDING VAN DE ONDERGROND.

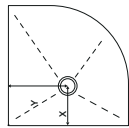

2.1 Om te installeren moet de afvoer overeenkomen met het midden van de afvoer van de douchebak.

## 2.4

Een vaste, stevige basis moet worden verkregen, zonder vervorming en volledig waterpas met cementmateriaal. Zorg ervoor dat het gat rond het ventiel niet hoger is dan 2 cm en niet onder het niveau van de basis ligt.

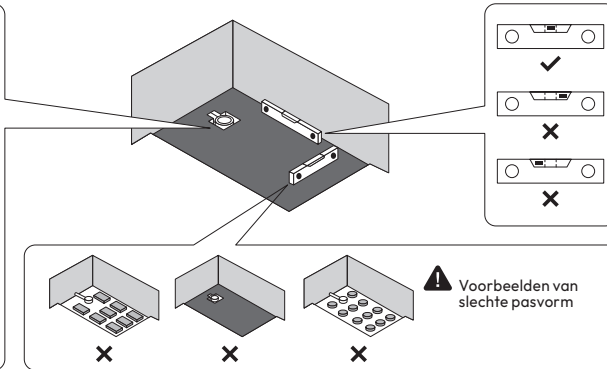
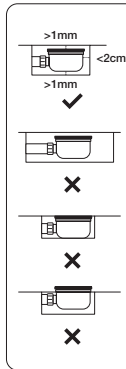

Voorbeelden van slechte pasvorm

## 2.2

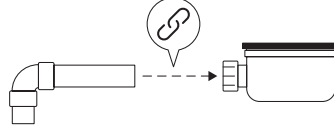

Controleer de verbinding tussen de afvoer en de afvoerbuis, zorg ervoor dat er geen lekkage is bij het vullen van de afvoer.

## 2.3

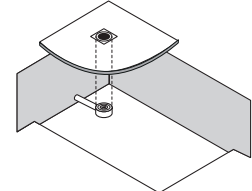

Installeer de afvoer zodat deze overeenkomt met het midden van de afvoer van de douchebak.

## 3. INSTALLATIE VAN DE DOUCHEBAK.

Voordat u lijm aanbrengt en verder gaat met de installatie, plaatst u de douchebak op de basis en sluit u de afvoer aan. Giet overvloedig water. Controleer of het water direct in de afvoer stroomt. Deze verificatie is erg belangrijk, wij accepteren geen klachten, vervangingen en terugbetalingen na installatie van de douchebak.

## 3.1

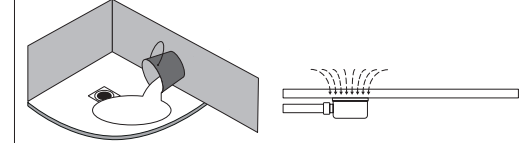

## 3.2 Installatie van de afvoer

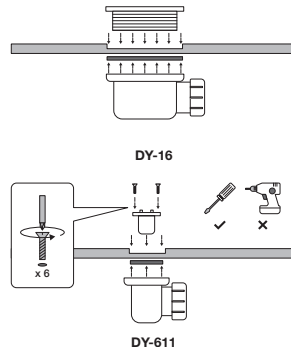
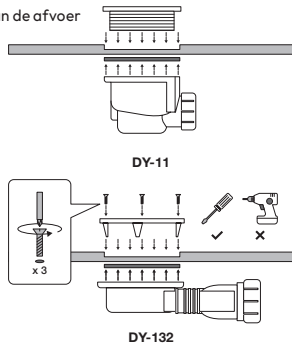

## 3.2

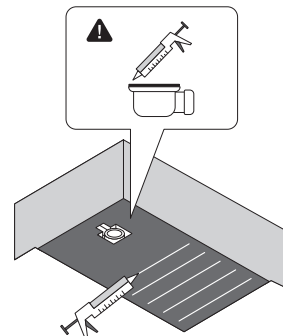

Voor de installatie van de afvoer brengt u voor de veiligheid een koord van siliconenkit aan.

Na alle controles en aanpassingen dicht u met siliconen langs rechte kieren.

## 3.4

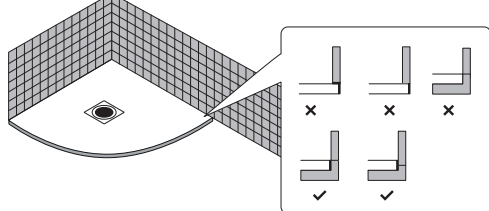

## 3.5

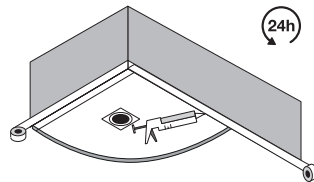

## 3.6

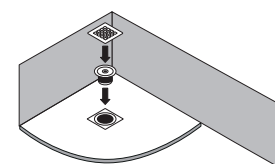

Bevestig de douchebak en voltooi de installatie van de cabine. Het is noodzakelijk om een ruimte van 2-3 mm te laten die is opgevuld met siliconenkit tussen de douchebak en de muur, tegels, panelen of een ander aangrenzend element. Als u tegels op de douchebak moet plaatsen, zorg ervoor dat het gewicht niet direct op de bak rust.

Bescherm de douchebak met afplaktape voordat u afdicht en isoleer de verbinding van de douchebak met de muren met siliconen. Laat 24 uur drogen.

Steek alleen de afvoerbuis in de sifon en schroef de centrale schroef vast, plaats de stalen afdekking in de vierkante holte in het midden van de douchebak.

## 3.7

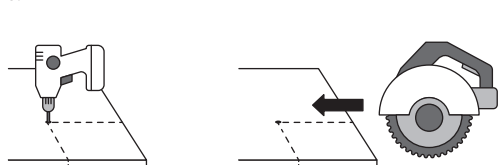

Boor een gat op het snijpunt van de twee snijlijnen, gebruik een diamantzaagschijf om van buiten naar het gat te snijden, precies volgens de snijlijn.

## 3.8

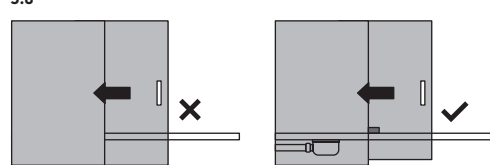

**WAARSCHUWING!** Verplaats nooit metalen profielen of glas over de douchebak om krasen te voorkomen.  
**WAARSCHUWING!** Laat geen resten van siliconen op de douchebak vallen tijdens de installatie van de cabine.

## 3.9

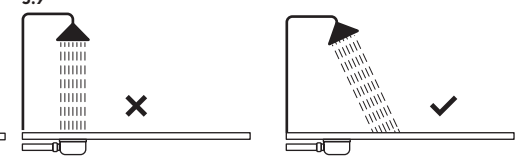

Het wordt aanbevolen dat water dat uit de douche spuit niet direct op de afdekking stroomt, omdat dit de afvoercapaciteit van de douchebak drastisch kan verminderen.



#### 4. SCHOONMAKEN

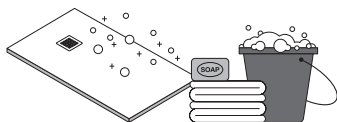

**4.1**  
**Voor routinematig schoonmaken:**  
 Maak de douchebak schoon met zeep en water, gebruikmakend van een zachte doek of schoonmaakdoekje. Gebruik nooit een schuringspons. Omdat dit een basisreiniging is, wordt aanbevolen dit dagelijks te doen.

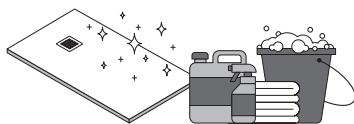

**Voor grondige reiniging:**  
 U kunt elk commercieel schoonmaakmiddel gebruiken, zelfs het sterkste, maar reinig het altijd na enkele minuten. Het is erg belangrijk om het niet uren op de douchebak te laten liggen, omdat dit ongewenste vlekken kan veroorzaken. In dit proces kunt u een doek of schoonmaakdoekje gebruiken, maar gebruik nooit een schuringspons.



**Maak na het werk schoon:**  
 Voor schoonmaken raden we aan zeep of een vergelijkbaar product te gebruiken. **GEBRUIK NOOIT EEN RVS BORSTEL (SCOTCHBRITE OF VERGELIJKBAAR)**, noch oplosmiddelen, zuren of schurende producten. Draag handschoenen, een beschermend masker en een bril.

#### 4.2



**Haarverproduct:** Als u meteen spoelt, wordt de douchebak niet aangetast. Als de verf enkele minuten op de douchebak blijft door onoplettendheid, zal deze vlekken achterlaten. Deze vlekken kunnen met de hand worden verwijderd.



**Siliconen- of vergelijkbare vlekken:** Om dit soort vlekken te verwijderen, gebruikt u een stuk hout en wrijft u voorzichtig totdat de vlek verdwijnt. Ze zijn gemakkelijker te verwijderen als u reinigt met citroenzuur of alcohol.



**Werkvlekken:** Cement-, pleistervlekken, enz.: In dit geval wordt het gebruik van zoutzuur aanbevolen. Laat het 2-3 minuten inwerken en spoel het vervolgens af met water. Het proces kan meerdere keren worden herhaald.

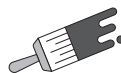

**Verfvlekken:** Moeilijker te verwijderen. De beste oplossing is om het aangetaste gebied te schuren en opnieuw te schilderen met een reparatieset.



**Kalk:** Kalkvlekken op alle donkere kleuren van de douchebak kunnen een probleem zijn in sommige geografische gebieden. Om het te verwijderen, kunt u elk commercieel kalkverwijderingsproduct gebruiken of een toiletreiniger met zoutzuur. Verwijder het roestvrijstalen rooster voordat u met dit soort chemisch product schoonmaakt (indien geïnstalleerd).

#### 5. ONDERHOUD

##### 5.1



Dekgel (200 ml)



Verharder (15 ml)



Schuimblok



Schuurpapier (320µm)



Krabber



Pluisvrije doek



Schraper

##### 5.2

1

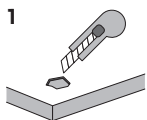

Gebruik een schraper om de dekkende gel van het beschadigde gebied te schrapen.

2

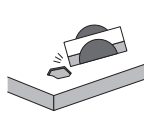

Gebruik schuurpapier om een schuimblok te wikkelen en schuur vervolgens het defecte gebied.

3

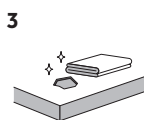

Breng aceton of ethylalcohol met water aan met een pluisvrije doek. Maak het oppervlak van de douchebak zeer goed schoon, het oppervlak moet volledig schoon en droog zijn.

4

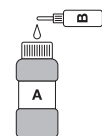

Bereid de reparatie-dekkende gel en verharder voor in de volgende verhoudingen (dekkende gel: verharder = 25:1).

5

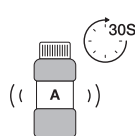

Schud vervolgens gedurende 30 seconden.

6

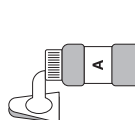

Neem wat reparatie-dekkende gel met een schraper.

7

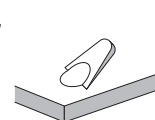

Repareer het gebroken deel tot vlakheid is bereikt.

##### 5.3

8

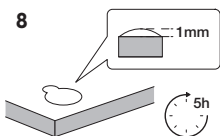

Laat tot slot 5 uur drogen.

9

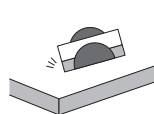

Schuur het gebied opnieuw met schuurpapier, behoud de textuur van het oppervlak.

10

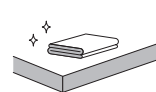

Maak vervolgens het oppervlak schoon met een droge, pluisvrije doek en breng vervolgens aceton of ethylalcohol met water aan met een pluisvrije doek.

#### 6. AANWIJZINGEN

- Douchebak alleen in de verpakking vervoeren, overbelasting vermijden.
- Niet in verticale positie plaatsen.
- Wij zijn niet verantwoordelijk voor schade veroorzaakt door onjuiste opslag of transport.
- De installatie moet uitsluitend worden uitgevoerd door een bevoegde specialist.
- Controleer altijd voor het monteren van de douchebak.
- Bescherm tijdens de installatie van de douchebak altijd de oppervlakken van de bak, de tegels en de wandtegels.
- Volg de instructies van de fabrikant bij het installeren van de afvoer.
- Vermijd alle soorten vuil, inclusief achtergelaten op afval.
- De muren waarop het verwijderbare paneel zich bevindt, moeten schoon, droog en vetvrij zijn.
- Om een juiste installatie te waarborgen, moeten de werkstappen in de juiste volgorde worden uitgevoerd.

#### GARANTIEVOORWAARDEN

- Garantieperiode:**  
De garantie is geldig voor 5 jaar vanaf de aankoopdatum.
- Omvang van de garantie:**  
Dekt materiaal- en fabricagefouten die aan het licht komen bij gebruik volgens de bedoelde doeleinden.
- Uitsluitingen van de garantie:**
  - Mechanische schade veroorzaakt door onjuist gebruik, transport of installatie.
  - Schade veroorzaakt door het gebruik van agressieve chemische middelen of onjuiste verzorging.
  - Normale slijtage van het product (bijv. kleine krassen, verkleuring).
- Voorwaarden voor het behoud van de garantie:**
  - Controleer het product op eventuele fabrieksfouten en juiste profielafwatering vóór de installatie.
  - De installatie moet worden uitgevoerd volgens de instructies van de fabrikant.
  - Het product moet worden verzorgd met alleen de aanbevolen reinigingsmiddelen.
- Klachtprocedure:**
  - In geval van een defect moet een klacht worden ingediend op de plaats van aankoop, onder voorlegging van het aankoopbewijs en een beschrijving van het defect.
  - De fabrikant behoudt zich het recht voor om het product te repareren, te vervangen of het geld terug te geven.
- Contact:**  
Alle vragen of inzendingen moeten worden gericht aan het adres van de fabrikant.



**BALNEO POLSKA**  
 tel: +48 22 740 72 74, +48 737 923 005, +48 799 787 334,  
 e-mail: [biuro@balneo.pl](mailto:biuro@balneo.pl)  
 more information on: [www.balneo.pl](http://www.balneo.pl)





## INSTALLERING AV DUSCHKAR

1. Inledande kontroll
2. Förberedelse av underlaget
3. Installering av duschkar
4. Rengöring
5. Underhåll
6. Riktlinjer



Nödvändiga verktyg:  
Måttband, Målartejp, Limcement, Hink, Handskar, Dispenser med silikonförsegling, Vattenpass, Skruvmejsel, Penna, Spackel

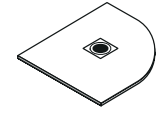

## 1. INLEDANDE KONTROLL

1.1 Kontrollera att duschkar inte är deformerad och att den inte har några slag eller repor. Kontrollera att modell, färg och textur är korrekta. Efter installation godtas inga byten eller reklamationer av ovanstående skäl.

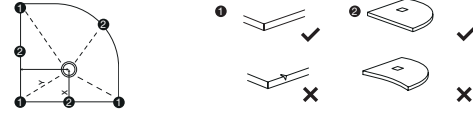

## 1.2



Duschkaret ska förvaras i horisontellt läge, var noga med att inte repa duschkaret med skruvar eller täckning.

## 1.3



Grundläggande installation.

Installation i nivå med golvet.

## 1.4

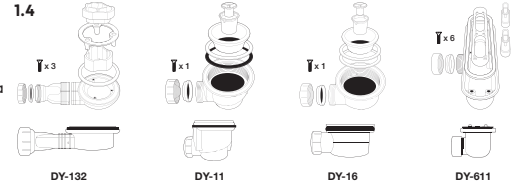

Kontrollera noggrant alla delar av avloppsventilen som du har fått.

## 2. FÖRBEREDELSE AV UNDERLAGET.

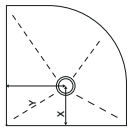

2.1 För att montera måste avloppet överensstämma med centrum av duscharens avlopp.

## 2.4

En fast och solid grund måste erhållas, inte deformerad och helt jämn med cementmaterial. Se till att hålet runt ventilen inte är högre än 2 cm och inte ligger under grundnivå.

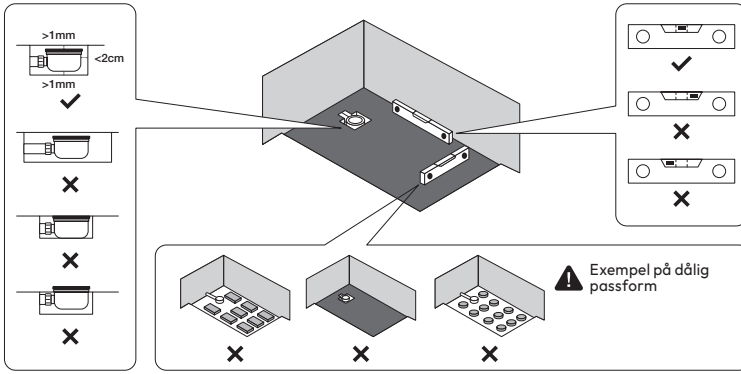

## 2.2

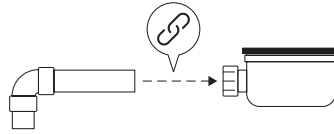

Kontrollera anslutningen mellan avloppet och avloppsröret, se till att det inte läcker när du håller vatten i avloppet.

## 2.3

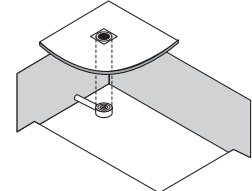

Installera avloppet så att det överensstämmer med centrum av duscharens avlopp.

## 3. INSTALLATION AV DUSCHKAR.

Innan du applicerar lim och fortsätter installationen, lägg duschkaret på grunden och anslut avloppet. Håll rikligt med vatten. Kontrollera att vattnet rinner direkt till avloppet. Denna kontroll är mycket viktig, vi accepterar inga reklamationer, byten eller återbetalningar efter installation av duschkaret.

## 3.1

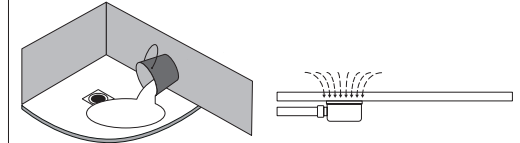

## 3.2

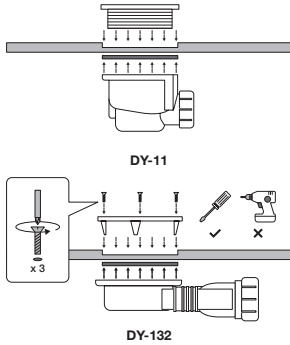

DY-11

DY-132

## 3.2

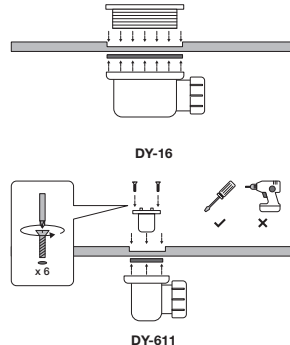

DY-16

DY-611

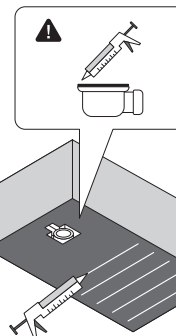

Installation av avlopp  
För att installera avloppet, applicera av säkerhetsskäl en sträng av silikonförsegling.

Efter alla kontroller och justeringar, täta med silikon längs raka sprickor.

## 3.4

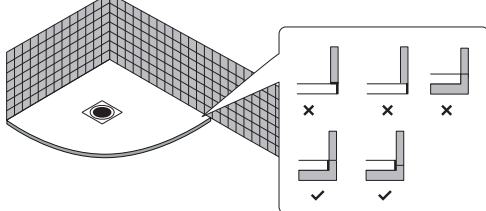

## 3.5

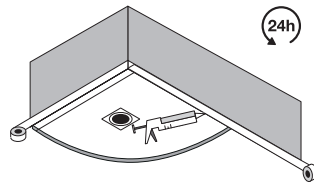

## 3.6

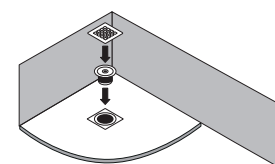

Fäst duschkaret och slutför installationen av kabinen, det är nödvändigt att lämna ett utrymme på 2-3 mm fyllt med silikonförsegling mellan duschkaret och väggen, plattorna, panelerna eller något annat intilliggande element. Om du måste lägga plattor på duschkaret, se till att vikten inte vilar direkt på karet.

Skydda duschkaret med maskeringstejp innan du tätar och isolera anslutningen mellan duschkaret och väggarna med silikon. Låt torka i 24 timmar.

Sätt bara avloppsröret i sifonen och skruva fast mittskruven, sätt ståltäckplåten i fyrkantshålet i mitten av duschkaret.

## 3.7

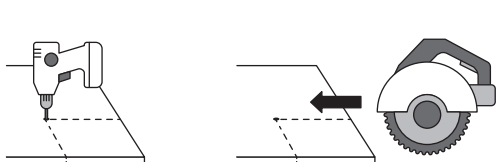

Borra ett hål vid skärningspunkten mellan de två skärningarna, använd en diamantskiva för att skära från utsidan till hålet, följ exakt skärningarna.

## 3.8

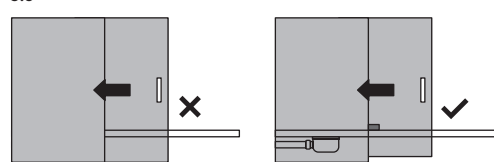

**WARNING!** Flytta aldrig metallprofiler eller glas över duschkaret för att undvika repor.  
**WARNING!** Låt inte silikonrester falla på duschkaret under installation av kabinen.

## 3.9

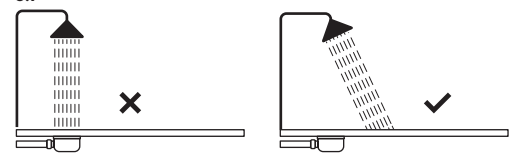

Det rekommenderas att vattnet från duschen inte rinner direkt på täckningen, eftersom detta drastiskt kan minska avloppets kapacitet i duschkaret.

#### 4. RENGÖRING

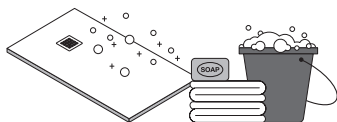

**4.1 För rutinnässig rengöring:**  
Rengör duschkaret med tvål och vatten, hjälp till med en mjuk trasa eller rengöringsduk. Använd aldrig en slipande svamp. Eftersom detta är en grundläggande rengöring rekommenderas det att utföra detta dagligen.

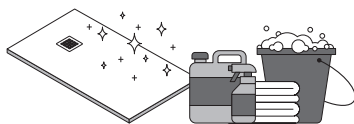

**För grundlig rengöring:**  
Du kan använda vilket kommersiellt rengöringsmedel som helst, till och med det starkaste, men rengör det alltid efter att ha låtit produkten verka i några minuter. Det är mycket viktigt att inte låta det vara på duschkaret i timmar eftersom det kan orsaka oönskade fläckar. I denna process kan du använda en trasa eller rengöringsduk, men använd aldrig en slipande svamp.



**Städa efter jobbet:**  
För rengöring rekommenderar vi att använda tvål eller en liknande produkt. **ANVÄND ALDRIG ROSTFRITT STÅLBORSTE (SCOT-CHBRITE ELLER LIKANDE)**, eller lösningsmedel, syror eller slipande produkter. Använd handskar, skyddsmask och skyddsglasögon.

#### 4.2



**Hårfärgningsprodukt:** Om du sköljer omedelbart påverkas inte duschkaret. Om färgen förblir på duschkaret i några minuter genom uppmärksamhet kommer det att lämna fläckar. Dessa fläckar kan tas bort genom handtvätt.



**Silikonfläckar eller liknande:** För att ta bort denna typ av fläckar, använd en träbit och gnid försiktigt tills fläcken försvinner. De är lättare att ta bort om du rengör med citronsyra eller alkohol.



**Arbetsfläckar:** Cement-, gipsfläckar, etc.: I detta fall rekommenderas användning av saltsyra. Låt verka i 2-3 minuter och skölj sedan med vatten. Processen kan upprepas flera gånger.

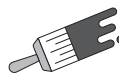

**Färgfläckar:** Svårare att ta bort. Den bästa lösningen är att slipa det drabbade området och måla om med ett reparationsfärg.



**Kalk:** Kalkfläckar på alla mörka färger av duschkaret kan vara ett problem i vissa geografiska områden. För att ta bort det kan du använda vilken kommersiell kalkborttagare som helst eller en toalettrengöringsgel som innehåller saltsyra. Ta bort rostfritt stål galleret innan du rengör med denna typ av kemisk produkt (om installerad).

#### 5. Underhåll

##### 5.1



Dekgel (200 ml)



Verharder (15 ml)



Schuimblok



Schuurpapier (320µm)



Krabber



Pluisvrije doek



Schraper

##### 5.2

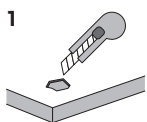

Använd en skrappa för att ta bort täckgelen från det skadade området. Använd sandpapper för att svepa in ett skumblock och slipa sedan det defekta området.

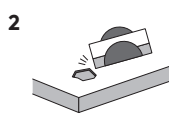

Applicera aceton eller etanol med vatten med en luddfria trasa.

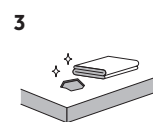

Rengör duschkarets yta mycket noggrant, ytan måste vara helt ren och torr.

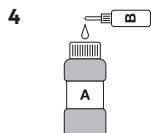

Förbered reparationsgelén och härdaren i följande proportioner (tätskiktsgel: härdare = 25:1).

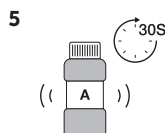

Skaka sedan i 30 sekunder.

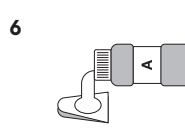

Ta lite reparationsgel med en skrappa.

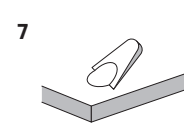

Reparera den skadade delen tills den är plan.

##### 5.3

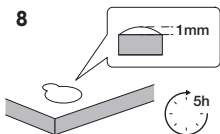

Låt slutligen torka i 5 timmar.

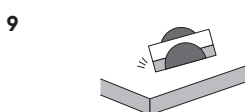

Slipa området igen med sandpapper, bibehåll ytans textur.

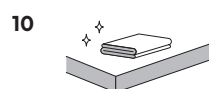

Rengör sedan ytan med en torr, luddfria trasa och applicera sedan aceton eller etanol med vatten med en luddfria trasa.

#### 6. RIKTLINJER

- Transportera duschkaret endast i förpackningen, undvik överbelastning.
- Placera inte i vertikalt läge.
- Vi ansvarar inte för skador som orsakats av felaktig lagring eller transport.
- Installation måste utföras av en auktoriserad specialist.
- Kontrollera alltid innan du monterar duschkaret.
- Vid montering av duschkaret, skydda alltid ytorna på duschkaret, kakel och vägglattor.
- För att installera avloppet, följ tillverkarens anvisningar.
- Undvik all slags smuts, inklusive kvarlämnad på avfall.
- Väggarna där det utbytbara panelen finns måste vara rena, torra och fettfria.
- För att säkerställa korrekt installation måste arbetsstegen utföras i rätt ordning.

#### GARANTI VILLKOR

- Garanti period:**  
Garantin gäller i 5 år från inköpsdatum.
- Garantis omfattning:**  
Täcker material- och tillverkningsfel som avslöjas vid användning enligt avsedd användning.
- Undantag från garantin:**
  - Mekaniska skador orsakade av felaktig användning, transport eller installation.
  - Skador till följd av användning av aggressiva kemikalier eller felaktig vård.
  - Naturligt slitage av produkten (t.ex. små repor, missfärgningar).
- Villkor för att upprätthålla garantin:**
  - Kontrollera produkten för eventuella fabriksfel och korrekt sluttande profil före installation.
  - Installationen måste utföras i enlighet med tillverkarens instruktioner.
  - Produkten bör vårdas med endast rekommenderade rengöringsmedel.
- Reklamationsförfarande:**
  - Vid upptäckt av defekt ska en reklamation lämnas in på inköpsstället genom att uppvisa köpbevis och en beskrivning av felet.
  - Tillverkaren förbehåller sig rätten att reparera, byta ut produkten eller återbetala pengarna.
- Kontakt:**  
Alla frågor eller förfrågningar bör riktas till tillverkarens adress.



**BALNEO POLSKA**  
tel: +48 22 740 72 74, +48 737 923 005, +48 799 787 334,  
e-mail: biuro@balneo.pl  
more information on: [www.balneo.pl](http://www.balneo.pl)



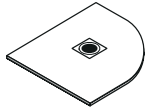

## INSTALAÇÃO DO PRATO DE DUCHE

1. Verificação inicial
2. Preparação da superfície
3. Instalação do prato de ducha
4. Limpeza
5. Manutenção
6. Dicas



Ferramentas necessárias:  
Fita métrica, Fita de pintor, Argamassa adesiva, Balde, Luvas,  
Dispensador com selante de silicone, Nível, Chave de fenda,  
Lápis, Colher de pedreiro

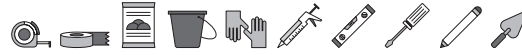

## 1. VERIFICAÇÃO INICIAL

1.1 Verifique se o prato de ducha não está deformado e não tem quaisquer impactos ou arranhões. Verifique se o modelo, a cor e a textura estão corretos. Após a instalação, não são aceites trocas nem reclamações pelos motivos acima mencionados.

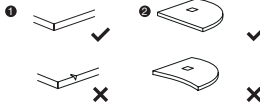
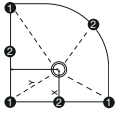

### 1.2

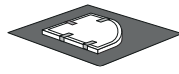

O prato de ducha deve ser armazenado na posição horizontal, tendo cuidado para não riscar o prato de ducha com parafusos ou coberturas.

### 1.3



Instalação básica.

Instalação ao nível do chão.

### 1.4

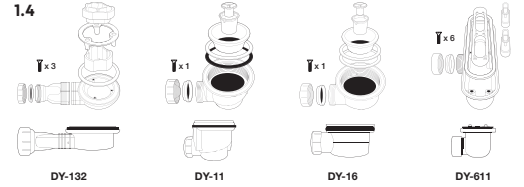

Verifique cuidadosamente todos os elementos da válvula de drenagem que recebeu.

## 2. PREPARAÇÃO DA SUPERFÍCIE.

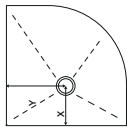

2.1 Para montar, o dreno deve coincidir com o centro do dreno do prato de ducha.

### 2.4

Deve obter uma base sólida, não deformada e completamente nivelada com material cimentício. Certifique-se de que o orifício em torno da válvula não está mais alto que 2 cm e não está abaixo do nível da base.

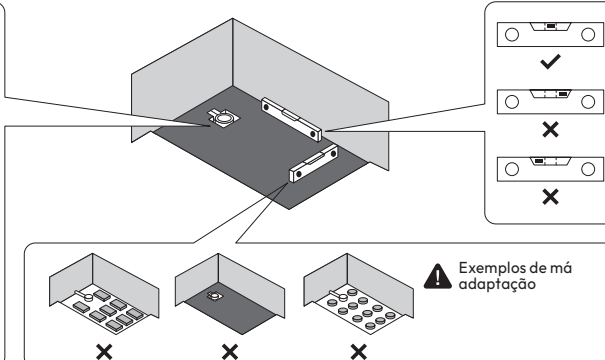
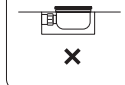
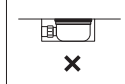
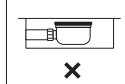
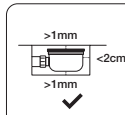

Exemplos de má adaptação

### 2.2

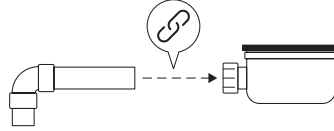

Verifique a conexão entre o dreno e o tubo de esgoto, certificando-se de que ao despejar água no dreno, não há vazamentos na conexão.

### 2.3

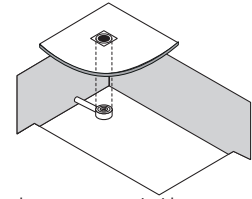

Instale o dreno para que coincida com o centro do dreno do prato de ducha.

## 3. INSTALAÇÃO DO PRATO DE DUCHE.

Antes de aplicar o adesivo e continuar a instalação, coloque o prato de ducha na base e conecte o dreno. Despeje bastante água. Verifique se a água flui diretamente para o dreno. Esta verificação é muito importante, não aceitamos reclamações, trocas ou reembolsos após a instalação do prato de ducha.

### 3.1

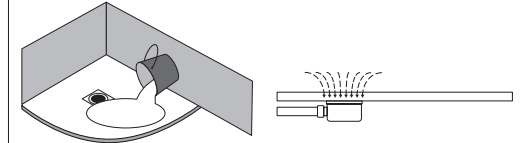

### 3.2 Instalação do dreno

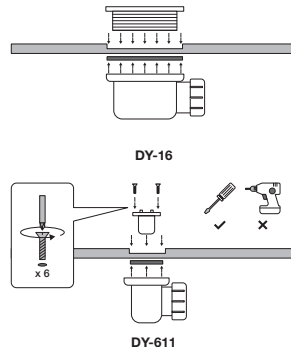
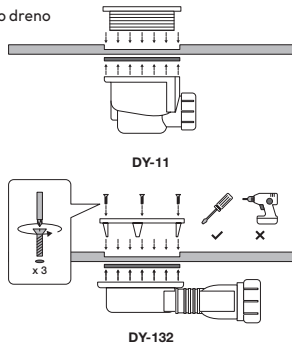

### 3.2

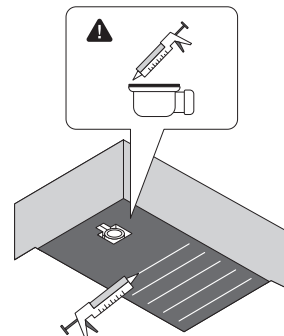

Para instalar o dreno, por segurança, aplique um cordão de selante de silicone.

Após todas as verificações e ajustes, sele com silicone ao longo das fendas retas.

### 3.4

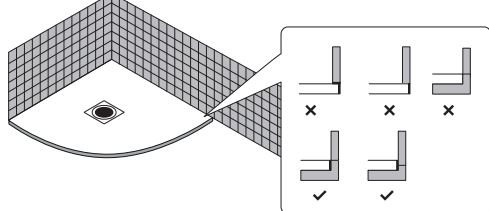

### 3.5

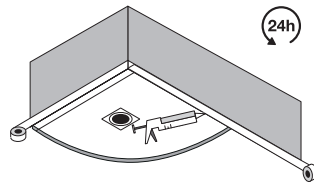

### 3.6

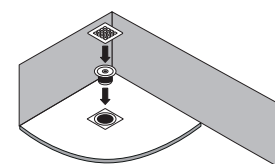

Fixe o prato de ducha e complete a instalação da cabina. É necessário deixar um espaço de 2-3 mm preenchido com selante de silicone entre o prato de ducha e a parede, azulejos, painéis ou qualquer outro elemento adjacente. Se precisar colocar azulejos no prato de ducha, certifique-se de que o peso não está diretamente sobre o prato.

Proteja o prato de ducha com fita adesiva antes de selar e isole a conexão do prato de ducha com as paredes com silicone. Deixe secar por 24 horas.

Insira apenas o tubo de drenagem no sifão e aperte o parafuso central, coloque a tampa de aço na cavidade quadrada no centro do prato de ducha.

### 3.7

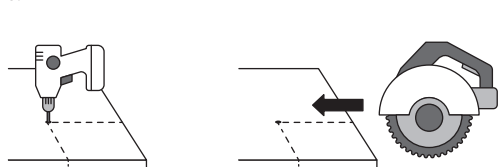

Perfure um orifício no ponto de interseção das duas linhas de corte, use um disco angular de diamante para cortar de fora para dentro do orifício, seguindo exatamente a linha de corte.

### 3.8

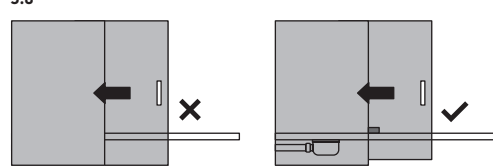

**AVISO!** Nunca deslize perfis metálicos ou vidro sobre o prato de ducha para evitar arranhões.  
**AVISO!** Não deixe cair restos de silicone no prato de ducha durante a instalação da cabina.

### 3.9

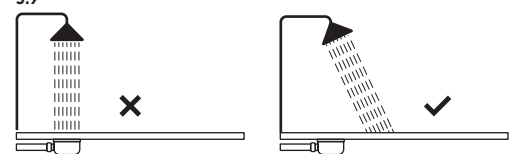

Recomenda-se que a água que espirra do chuveiro não flua diretamente sobre a tampa, pois isso pode diminuir drasticamente a eficiência do dreno do prato de ducha.

#### 4. LIMPEZA

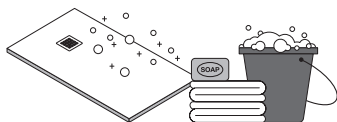

**4.1 Para limpeza de rotina:**  
Limpe o prato de duche com sabão e água, auxiliando a limpeza com um pano macio ou pano de limpeza. Nunca use uma esponja abrasiva. Como esta é uma limpeza básica, recomenda-se realizá-la diariamente.

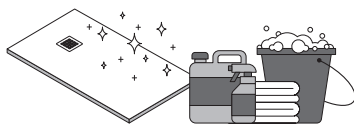

**Para limpeza profunda:**  
Pode usar qualquer detergente comercial, mesmo o mais forte, mas sempre limpe após deixar o produto agir por alguns minutos. É muito importante não deixá-lo no prato de duche por horas, pois isso pode causar manchas indesejadas. Neste processo, pode usar um pano ou um pano de limpeza, mas nunca use uma esponja abrasiva.



**Limpe após o trabalho:**  
Para a limpeza, sugerimos usar sabão ou um produto semelhante. **NUNCA USE ESCOVAS DE AÇO INOXIDÁVEL (SCOTCHBRITE OU SIMILARES)**, nem solventes, ácidos ou produtos abrasivos. Use luvas, máscara protetora e óculos.

#### 4.2



**Produto para tingir o cabelo:** Se enxaguar imediatamente, o prato de duche não será afetado. Caso a tinta permaneça no prato de duche por alguns minutos por descuido, deixará manchas. Estas manchas podem ser removidas lavando à mão.



**Manchas de silicone ou semelhantes:** Para remover este tipo de manchas, use um pedaço de madeira e esfregue cuidadosamente até que a mancha desapareça. São mais fáceis de remover se limpar com ácido cítrico ou álcool.



**Manchas de obras:** Manchas de cimento, gesso, etc.: Neste caso, recomenda-se usar ácido clorídrico. Deixe agir na mancha por 2-3 minutos e depois enxague com água. O processo pode ser repetido várias vezes.

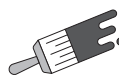

**Manchas de tinta:** Mais difíceis de remover. A melhor solução é lixar a área afetada e repintar com um kit de reparação.



**Cal:** Manchas de cal em todas as cores escuras do prato de duche podem ser um problema em algumas áreas geográficas. Para removê-las, pode usar qualquer produto comercial de remoção de calcário ou gel de limpeza de WC que contenha ácido clorídrico. Remova a grelha de aço inoxidável antes de limpar com este tipo de produto químico (se instalada).

#### 5. MANUTENÇÃO

##### 5.1



Gel de cobertura (200 ml)



Endurecedor (15 ml)



Bloco de espuma



Lixa (320µm)



Placa para raspar



Pano sem fiapos



Raspador

##### 5.2

1

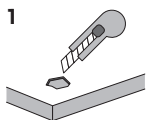

Use um raspador para remover o gel de cobertura da área danificada. Use lixa para envolver um bloco de espuma e depois lixe a área defeituosa.

2

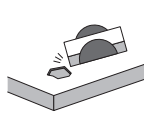

Aplique acetona ou álcool etílico com água usando um pano sem fiapos.

3

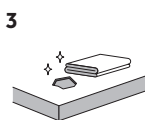

Limpe muito bem a superfície do prato de duche, a superfície deve estar completamente limpa e seca.

4

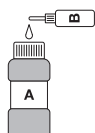

Prepare o gel de cobertura de reparação e o endurecedor nas seguintes proporções (gel de cobertura: endurecedor = 25:1).

5

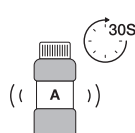

Em seguida, agite por 30 segundos.

6

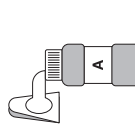

Pegue um pouco de gel de cobertura de reparação com uma espátula.

7

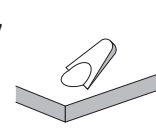

Repare a parte danificada até que fique nivelada.

##### 5.3

8

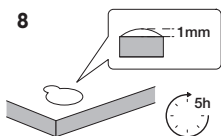

Finalmente, deixe secar por 5 horas.

9

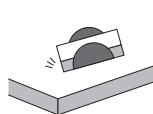

Lixe novamente a área com lixa, mantendo a textura da superfície.

10

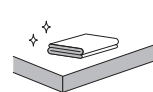

Em seguida, limpe a superfície com um pano seco sem fiapos e aplique acetona ou álcool etílico com água usando um pano sem fiapos.

#### 6. DICAS

- Transportar o prato de duche apenas na embalagem, evitar cargas excessivas.
- Não colocar na posição vertical.
- Não nos responsabilizamos por danos causados por armazenamento ou transporte inadequados.
- A instalação deve ser realizada exclusivamente por um especialista autorizado.
- Verifique sempre antes de instalar o prato de duche.
- Durante a instalação do prato de duche, proteja sempre as superfícies do prato, dos azulejos e das paredes.
- Para instalar o dreno, siga as instruções do fabricante.
- Evite todo tipo de sujeira, inclusive a deixada nos resíduos.
- As paredes onde está localizado o painel removível devem estar limpas, secas e desengorduradas.
- Para garantir uma instalação correta, as etapas de trabalho devem ser realizadas na ordem adequada.

#### CONDIÇÕES DE GARANTIA

- Período de garantia:**  
A garantia é válida por 5 anos a partir da data de compra.
- Âmbito da garantia:**  
Cobre defeitos de material e de fabricação revelados durante o uso conforme a finalidade prevista.
- Exclusões da garantia:**
  - Danos mecânicos causados por uso, transporte ou instalação inadequados.
  - Danos resultantes do uso de agentes químicos agressivos ou cuidados inadequados.
  - Desgaste natural do produto (por exemplo, pequenos riscos, descolorações).
- Condições para manter a garantia:**
  - Verifique o produto quanto a possíveis defeitos de fábrica e perfil de inclinação correto antes da instalação.
  - A instalação deve ser realizada de acordo com as instruções do fabricante.
  - O produto deve ser cuidado usando apenas agentes de limpeza recomendados.
- Procedimento de reclamação:**
  - Em caso de defeito, a reclamação deve ser apresentada no local de compra, apresentando prova de compra e uma descrição do defeito.
  - O fabricante reserva-se o direito de reparar, substituir o produto ou devolver o dinheiro.
- Contacto:**  
Todas as perguntas ou submissões devem ser dirigidas ao endereço do fabricante.



**BALNEO POLSKA**  
tel: +48 22 740 72 74, +48 737 923 005, +48 799 787 334,  
e-mail: biuro@balneo.pl  
more information on: [www.balneo.pl](http://www.balneo.pl)



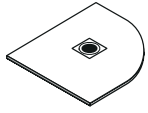

## MONTAJUL CĂDIȚEI DE DUȘ

1. Verificare inițială
2. Pregătirea suprafeței
3. Montajul cădiței de duș
4. Curățare
5. Întreținere
6. Instrucțiuni



Unelte necesare:  
 Bandă de măsurare, Bandă de pictor, Mortar adeziv, Găleată,  
 Mănuși, Dispenser cu etanșant de silicon, Nivelă, Șurubelniță,  
 Creion, Gletieră



## 1. VERIFICARE INIȚIALĂ

1.1 Verificați dacă cădița de duș nu este deformată și nu prezintă lovituri sau zgârieturi. Verificați dacă modelul, culoarea și textura sunt corecte. După instalare, nu sunt acceptate schimburi sau reclamații din motivele menționate mai sus.

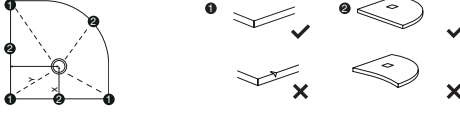

### 1.2

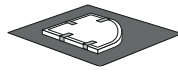

Cădița de duș trebuie depozitată în poziție orizontală, având grijă să nu zgâriați cădița cu șuruburi sau capace.

### 1.3

Instalație de bază.

Instalare la nivelul podelei.

### 1.4

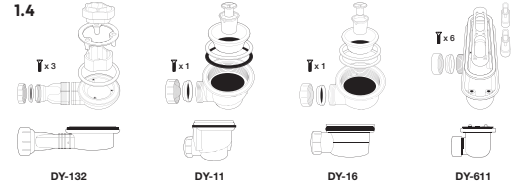

Verificați cu atenție toate elementele supapei de scurgere pe care le-ați primit.

## 2. PREGĂTIREA SUPRAFEȚEI.

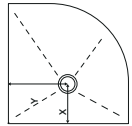

2.1 Pentru a monta, scurgerea trebuie să coincidă cu centrul scurgerii cădiței de duș.

### 2.4

Trebuie să obțineți o bază solidă, nedeformată și complet nivelată cu material ciment. Asigurați-vă că orificiul din jurul supapei nu este mai înalt de 2 cm și nu se află sub nivelul bazei.

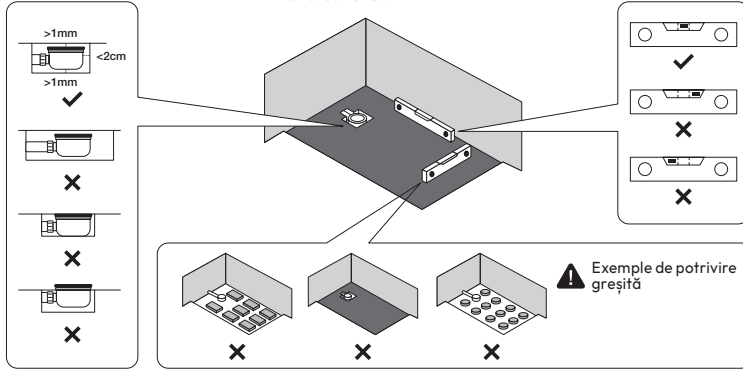

### 2.2

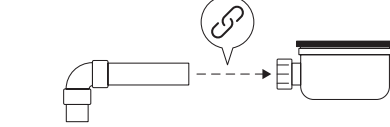

Verificați conexiunea dintre scurgere și conducta de evacuare, asigurându-vă că, turnând apă în scurgere, nu există scurgeri la îmbinarea vanei.

### 2.3

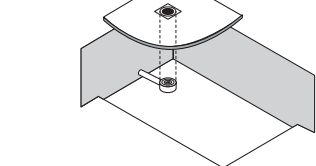

Instalați scurgerea astfel încât să coincidă cu centrul scurgerii cădiței de duș.

## 3. INSTALAREA CĂDIȚEI DE DUȘ.

Înainte de a aplica adezivul și de a continua instalarea, așezați cădița de duș pe bază și conectați scurgerea. Turnați multă apă. Verificați dacă apa curge direct în scurgere. Această verificare este foarte importantă, nu acceptăm reclamații, schimburi și rambursări după instalarea cădiței de duș.

### 3.1

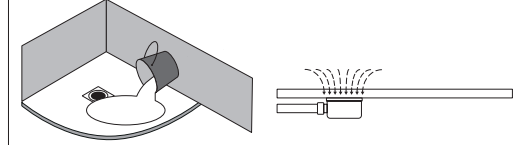

### 3.2 Instalarea scurgerii

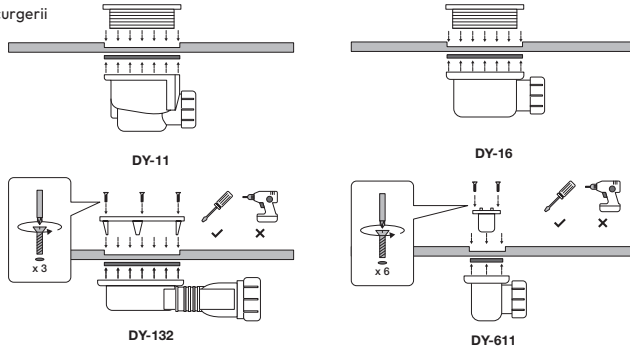

### 3.2

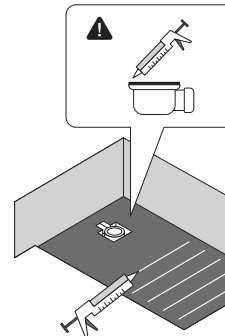

Pentru a instala scurgerea, pentru siguranță, aplicați un cordon de etanșant siliconic.

După toate verificările și reglajele, etanșați cu silicon de-a lungul fantele drepte.

### 3.4

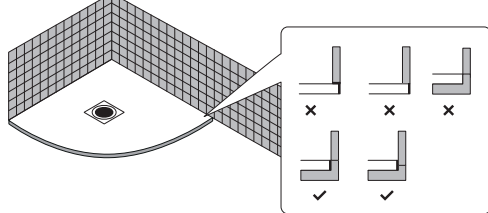

### 3.5

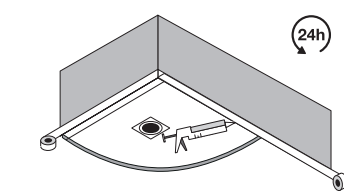

### 3.6

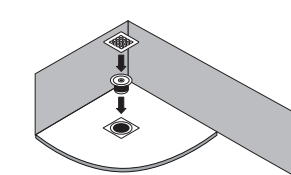

Fixați cădița de duș și finalizați instalarea cabinei, este necesar să lăsați un spațiu de 2-3 mm umplut cu etanșant siliconic între cădița de duș și perete, plăci, panouri sau orice alt element adiacent. Dacă trebuie să puneți plăci pe cădița de duș, asigurați-vă că greutatea nu se sprijină direct pe cădiță.

Protejați cădița de duș cu bandă adezivă înainte de etanșare și izolați conexiunea cădiței de duș cu pereții cu silicon. Lăsați să se usuce timp de 24 de ore.

Introduceți doar conducta de scurgere în sifon și înșurubați șurubul central, așezați capacul de oțel în adâncitura pătrată din mijlocul cădiței de duș.

### 3.7

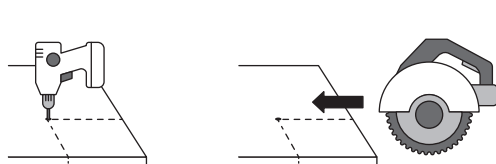

Găuriți un orificiu la punctul de intersecție al celor două linii de tăiere, utilizați un disc de diamant pentru a tăia de la exterior către orificiu, urmărind exact linia de tăiere.

### 3.8

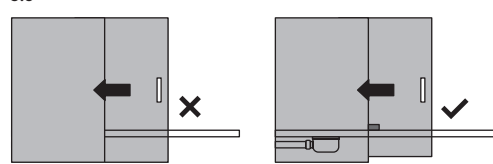

**AVERTISMENT!** Nu deplasați niciodată profilele metalice sau sticlă pe cădița de duș pentru a evita zgârieturile.  
**AVERTISMENT!** Nu lăsați reziduurile de silicon să cadă pe cădița de duș în timpul instalării cabinei.

### 3.9

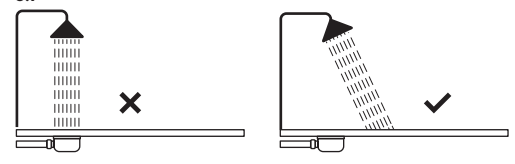

Se recomandă ca apa care se stropeste din duș să nu curgă direct pe capac, deoarece acest lucru poate reduce drastic eficiența scurgerii cădiței de duș.



#### 4. CURĂȚARE

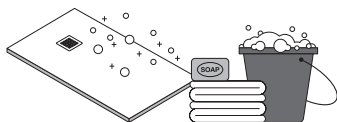

##### 4.1

##### Pentru curățarea de rutină:

Curățați cădița de duș cu săpun și apă, ajutând curățarea cu o cârpă moale sau o cârpă de curățare. Nu folosiți niciodată un burete abraziv. Deoarece aceasta este o curățare de bază, se recomandă efectuarea acesteia zilnic.

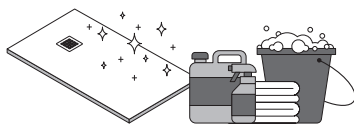

##### Pentru curățare profundă:

Puteți folosi orice detergent comercial, chiar și cel mai puternic, dar curățați întotdeauna după ce ați lăsat produsul să acționeze câteva minute. Este foarte important să nu îl lăsați pe cădița ore întregi, deoarece acest lucru poate provoca pete nedorite. În acest proces, puteți folosi o cârpă sau o cârpă de curățare, dar nu folosiți niciodată un burete abraziv.



##### Curățați după muncă:

Pentru curățare, vă sugerăm să folosiți săpun sau un produs similar. **NU FOLOSIȚI NICIODATĂ O PERIE DE OȚEL INOXIDABIL (SCOTCH-BRITE SAU SIMILAR)**, nici solvenți, acizi sau produse abrazive. Folosiți mănuși, mască de protecție și ochelari.

##### 4.2



Produs pentru vopsirea părului: Dacă clătiți imediat, cădița de duș nu va fi afectată. În cazul în care vopseaua rămâne pe cădița câteva minute din neatenție, va lăsa pete. Aceste pete pot fi îndepărtate prin spălare manuală.



Pete de silicon sau similare: Pentru a îndepărta acest tip de pete, utilizați o bucată de lemn și frecăți cu atenție până când petele dispar. Sunt mai ușor de îndepărtat dacă curățați cu acid citric sau alcool.



Pete de lucru: Pete de ciment, tencuială etc.: În acest caz, se recomandă utilizarea acidului clorhidric. Lăsați să acționeze timp de 2-3 minute pe pată și apoi clătiți cu apă. Procesul poate fi repetat de mai multe ori.

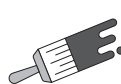

Pete de vopsea: Mai greu de îndepărtat. Cea mai bună soluție este șlefuirea zonei afectate și repictarea cu un set de reparații.



Calcar: Petele de calcar pe toate culorile închise ale cădiței de duș pot fi o problemă în unele zone geografice. Pentru a le îndepărta, puteți folosi orice produs comercial pentru îndepărtarea calcarului sau un gel de curățare a toaletei care conține acid clorhidric. Îndepărtați grila din oțel inoxidabil înainte de a curăța cu acest tip de produs chimic (dacă este instalată).

#### 5. ÎNTREȚINERE

##### 5.1



Gel de acoperire (200 ml)



Întăritor (15 ml)



Bloc de spumă



Șmirghel (320μm)



Placă de răzuit



Cârpă fără scame



Răzuitor

##### 5.2

1

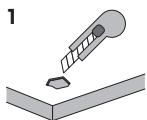

Utilizați o racletă pentru a îndepărta gelul de acoperire din zona deteriorată.

2

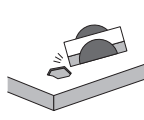

Utilizați șmirghel pentru a înfășura un bloc de spumă și apoi șlefuiți zona defectă.

3

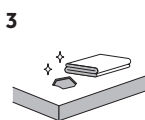

Aplicați acetona sau alcool etilic cu apă folosind o cârpă fără scame. Curățați foarte bine suprafața cădiței de duș, suprafața trebuie să fie complet curată și uscată.

4

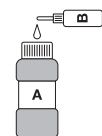

Pregătiți gelul de acoperire de reparație și întăritor în următoarele proporții (gel de acoperire: întăritor = 25:1).

5

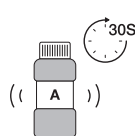

Apoi agitați timp de 30 de secunde.

6

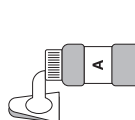

Luați puțin gel de acoperire de reparație cu o racletă.

7

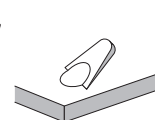

Reparați partea deteriorată până când se obține netezimea.

##### 5.3

8

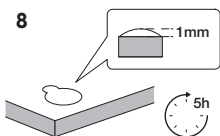

În final, lăsați să se usuce timp de 5 ore.

9

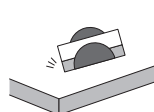

Șlefuiți din nou zona cu șmirghel, menținând textura suprafeței.

10

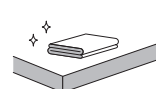

Apoi curățați suprafața cu o cârpă uscată fără scame și aplicați acetona sau alcool etilic cu apă folosind o cârpă fără scame.

#### 6. INSTRUCȚIUNI

- Transportați cădița de duș doar în ambalajul său, evitați supraîncărcările.
- Nu poziționați vertical.
- Nu suntem responsabili pentru daunele cauzate de depozitarea sau transportul necorespunzător.
- Instalarea trebuie efectuată exclusiv de un specialist autorizat.
- Verificați întotdeauna înainte de a monta cădița de duș.
- În timpul montajului cădiței de duș, protejați întotdeauna suprafețele cădiței, plăcilor, faianței.
- Pentru a instala scurgerea, urmați instrucțiunile producătorului.
- Evitați orice fel de murdărie, inclusiv cea lăsată pe deșeu.
- Pereții pe care se află panoul amovibil trebuie să fie curați, uscați și degresați.
- Pentru a asigura o instalare corectă, etapele de lucru trebuie efectuate în ordinea corectă.

#### CONDIȚII DE GARANȚIE

- Perioada de garanție:**  
Garanția este valabilă timp de 5 ani de la data achiziției.
- Domeniul garanției:**  
Acoperă defectele de materiale și de fabricație dezvăluite în timpul utilizării în conformitate cu scopul prevăzut.
- Excluderi de la garanție:**
  - Daune mecanice cauzate de utilizare, transport sau instalare necorespunzătoare.
  - Daune rezultate din utilizarea agenților chimici agresivi sau îngrijirea neadecvată.
  - Uzura naturală a produsului (de exemplu, mici zgărieturi, decolorare).
- Condiții pentru menținerea garanției:**
  - Verificarea produsului pentru eventualele defecte de fabrică și profilarea corectă a pantei înainte de instalare.
  - Instalarea trebuie să se efectueze conform instrucțiunilor producătorului.
  - Produsul trebuie întreținut folosind doar agenți de curățare recomandați.
- Procedura de reclamație:**
  - În cazul unei defecțiuni, reclamația trebuie depusă la locul de achiziție, prezentând dovada achiziției și o descriere a defectului.
  - Producătorul își rezervă dreptul de a repara, înlocui produsul sau returna banii.
- Contact:**  
Toate întrebările sau sesizările trebuie adresate la adresa producătorului.



**BALNEO POLSKA**  
tel: +48 22 740 72 74, +48 737 923 005, +48 799 787 334,  
e-mail: biuro@balneo.pl  
more information on: [www.balneo.pl](http://www.balneo.pl)



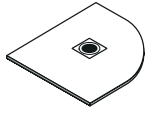

## ZUHANYTÁLCA TELEPÍTÉSE

1. Kezdeti ellenőrzés
2. Az aljzat előkészítése
3. Zuhanytálca telepítése
4. Tisztítás
5. Karbantartás
6. Útmutatások



**Szükséges eszközök:**  
Mérőszalag, Festőszalag, Ragasztómortar, Vödör, Kesztyűk, Adagoló szilikon tömítővel, Vízmérték, Csavarhúzó, Ceruza, Simító



## 1. KEZDETI ELLENŐRZÉS

1.1 Ellenőrizze, hogy a zuhanytálca nem néz-e ki deformáltnak és nincsenek rajta ütések vagy karcok. Ellenőrizze, hogy a modell, a szín és a textúra helyes-e. A telepítés után az említett okok miatt cseré vagy reklamáció nem fogadható el.

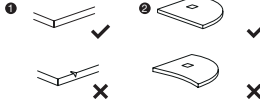
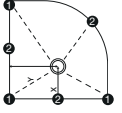

## 1.2

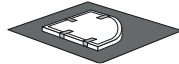

A zuhanytálcát vízszintes helyzetben kell tárolni, ügyelve arra, hogy ne karkolja meg a tálcát csavarokkal vagy burkolatokkal.

## 1.3



Alapvető telepítés. Telepítés padlósinten.

## 1.4

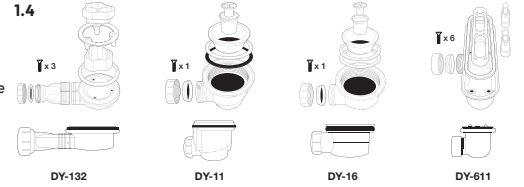

Ellenőrizze alaposan a kapott leeresztőszelvény összes elemét.

## 2. AZ ALJZAT ELŐKÉSZÍTÉSE.

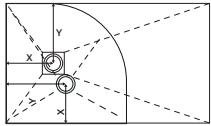

2.1 A felszereléshez a lefolyónak egybe kell esnie a zuhanytálca lefolyójának középpontjával.

## 2.4

Szilárd, nem deformált és teljesen kiegyenlített alapot kell biztosítani cementes anyaggal. Ügyeljen arra, hogy a szelep körüli lyuk ne legyen 2 cm-nél magasabb és ne legyen az alap szintje alatt.

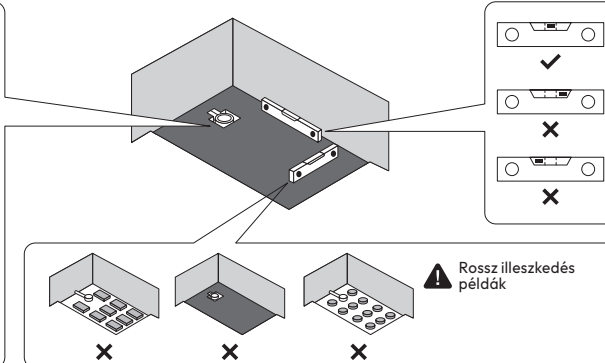
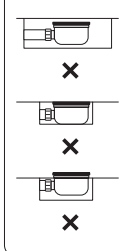
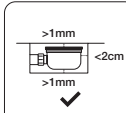

Rossz illeszkedés példák

## 2.2

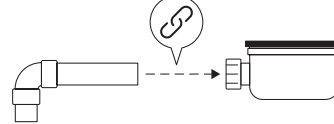

Ellenőrizze a kapcsolatot a lefolyó és a kifolyócső között, ügyelve arra, hogy víz beöntésekor ne szívárogjon a kapcsolatnál.

## 2.3

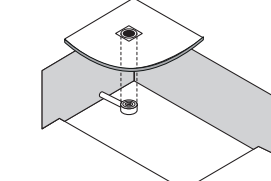

Szerelje fel a lefolyót úgy, hogy az egybeessen a zuhanytálca lefolyójának középpontjával.

## 3. A ZUHANYTÁLCA TELEPÍTÉSE.

Mielőtt felviszi a ragasztót és folytatja a telepítést, helyezze a zuhanytálcát az alapra, és csatlakoztassa a lefolyót. Öntsön bőséges vizet. Ellenőrizze, hogy a víz közvetlenül a lefolyóba folyik-e. Ez az ellenőrzés nagyon fontos, a zuhanytálca telepítése után nem fogadunk el reklamációkat, cseréket és visszatérítéseket.

## 3.1

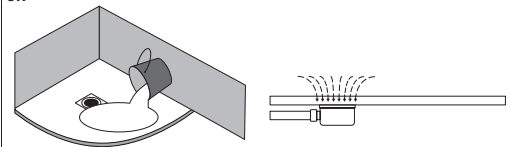

## 3.2 A lefolyó telepítése

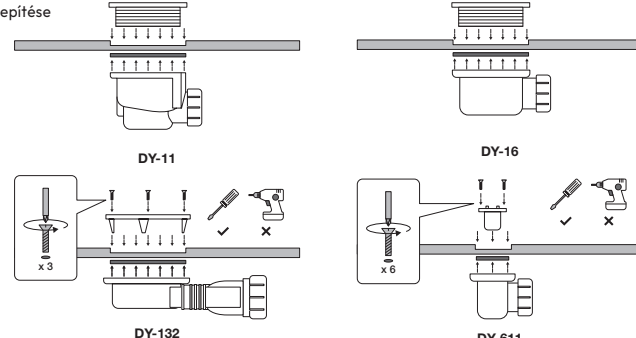

## 3.2

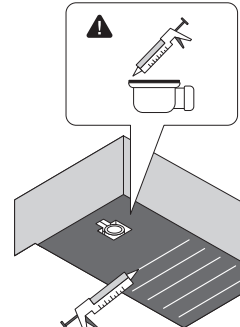

A lefolyó telepítése érdekében a biztonság érdekében szilikon tömítőszínórt kell alkalmazni. Az összes ellenőrzés és beállítás után tömítse le szilikonral az egyes repedések mentén.

## 3.4

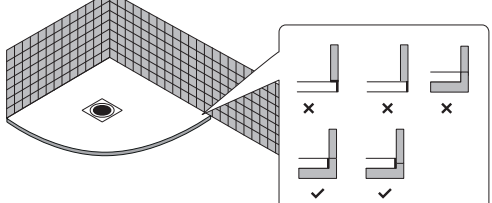

## 3.5

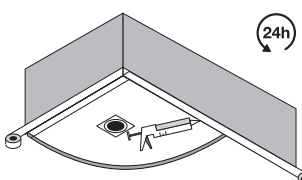

## 3.6

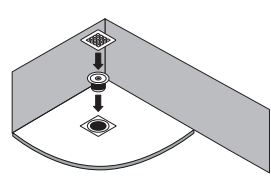

Rögzítse a zuhanytálcát és fejezze be a kabin telepítését, szükséges, hogy 2-3 mm-es hely maradjon, amely szilikon tömítővel van kiegészítve a zuhanytálca és a fal, csempék, panelek vagy bármely más szomszédos elem között. Ha csempét kell helyezni a zuhanytálca alá, ügyeljen arra, hogy a súly ne nyomja közvetlenül a tálcát.

Védje a zuhanytálcát maszkolószalaggal a tömítés előtt, és szilikonral szigetelje a zuhanytálca és a fal közötti kapcsolatot. Hagyja száradni 24 órán át.

Csak helyezze be a lefolyócsövet a szifonba, és húzza meg a központi csavart, helyezze a rozsdamentes acél burkolatot a zuhanytálca középen található négyzetes mélyedésbe.

## 3.7

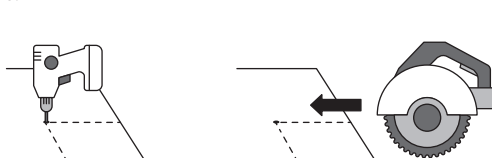

## 3.8

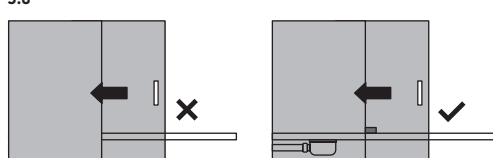

## 3.9

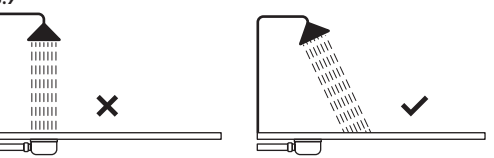

FIGYELEM! Fúrjon egy lyukat a két vágóvonal metszéspontjánál, használjon gyémánt vágótárcsát a külső résztől a lyukig történő vágáshoz, pontosan követve a vágóvonalat.

FIGYELEM! Soha ne mozgassa a fémpofilokat vagy üveget a zuhanytálcán, hogy elkerülje a karcolásokat. FIGYELEM! Ne hagyja, hogy a felesleges szilikon a kabin telepítésekor a zuhanytálca alá essen.

Javasoljuk, hogy a zuhanyból kilocsanó víz ne folyjon közvetlenül a burkolatra, mivel ez drasztikusan csökkentheti a zuhanytálca lefolyási kapacitását.

#### 4. TISZTÍTÁS

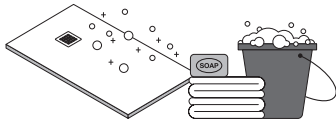

4.1

##### A rutin tisztításhoz:

Tisztítsa meg a zuhanytálcát szappannal és vízzel, puha anyag vagy tisztítókendő segítségével. Soha ne használjon súrolószivacsot. Mivel ez egy alapvető tisztítás, javasoljuk annak napi elvégzését.

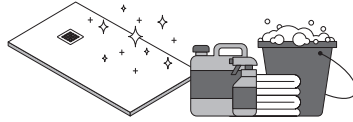

##### Az alapos tisztításhoz:

Bármilyen kereskedelmi tisztítószerrel használhatja, még a legerősebbet is, de mindig tisztítsa meg, miután hagyta a terméket néhány percig hatni. Nagyon fontos, hogy ne hagyja órákig a zuhanytálcán, mert ez nem kívánt foltokat okozhat. Ebben a folyamatban használhat kendőt vagy tisztítókendőt, de soha ne használjon súrolószivacsot.



##### Takarítás után:

Tisztításhoz javasoljuk, hogy használjon szappant vagy hasonló terméket. **SÓHA NE HASZNÁLJON ROZSDAMENTES ACÉL KEFÉT (SCOTCHBRITE VAGY HASONLÓ)**, sem oldószereket, savakat vagy abrazív termékeket. Viseljen kesztyűt, védőmaszkot és szemüveget.

4.2



**Hajfesték:** Ha azonnal kiöblíti, a zuhanytálca nem sérül meg. Ha a festék néhány percig a zuhanytálcán marad figyelmetlenségből, foltokat hagy. Ezek a foltok kézi mosással eltávolíthatók.



**Szilikon vagy hasonló foltok:** Az ilyen típusú foltok eltávolításához használjon egy darab fát és óvatosan dörzsölje, amíg a folt el nem tűnik. Könnyebben eltávolíthatók, ha citromsavval vagy alkohollal tisztítanak.



**Munka foltok:** Cement-, vakolatfoltok stb.: Ebben az esetben ajánlott sósavat használni. Hagyja 2-3 percig hatni a foltot, majd öblítse le vízzel. Az eljárás többször is megismételhető.

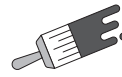

**Festékfoltok:** Nehezebb eltávolítani. A legjobb megoldás a sérült terület csiszolása és újrafestése javítóköszeggel.



**Vízfoltok:** A zuhanytálca összes sötét színű vízfoltja problémát jelenthet néhány földrajzi területen. Eltávolításukhoz bármilyen kereskedelmi vízkőtávolító terméket vagy sósavat tartalmazó WC-gélt használhat. A rozsdamentes acél rácstól távolítsa el, mielőtt ezzel a fajta vegyi anyaggal tisztítana (ha telepítve van).

#### 5. KARBANTARTÁS

5.1



Gel de acoperire (200 ml)



Íntáritör (15 ml)



Bloc de spumă



Șmirghel (320μm)



Placă de răzuire



Cârpă fărâ scame

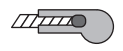

Răzuitor

5.2

1

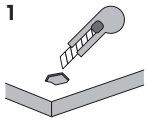

Használjon kaparót a sérült területen lévő fedőréteg eltávolításához. Használjon csiszolópapírt, hogy körbetekernyen egy habblokkot, majd csiszolja meg a hibás területet.

2

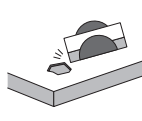

Vigyen fel acetont vagy etil-alkoholt vízzel egy bolyhosmentes ruhával.

3

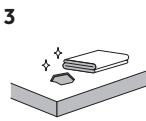

Nagyon jól tisztítsa meg a zuhanytálca felületét, a felületnek teljesen tisztának és száraznak kell lennie.

4

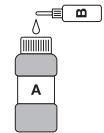

Készítse el a javító fedőréteget és az edzőt a következő arányokban (fedőréteg: edző = 25:1).

5

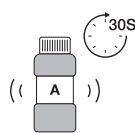

Ezután rázza 30 másodpercig.

6

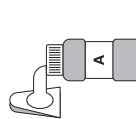

Vegyen egy kis javító fedőréteget egy kaparóval.

7

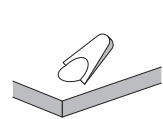

Javítsa meg a sérült részt, amíg sima nem lesz.

5.3

8

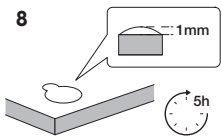

Végül hagyja száradni 5 órán át.

9

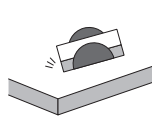

Csiszolja meg újra a területet csiszolópapírral, megőrizve a felület textúráját.

10

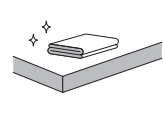

Ezután tisztítsa meg a felületet egy száraz, bolyhosmentes ruhával, majd vigyen fel acetont vagy etil-alkoholt vízzel egy bolyhosmentes ruhával.

#### 6. ÚTMUTATÁSOK

- A zuhanytálcát csak csomagolásban szállítsa, kerülje a túlterhelést.
- Ne helyezze függőlegesen helyzetbe.
- Nem vállalunk felelősséget a nem megfelelő tárolás vagy szállítás okozta károkért.
- A telepítést kizárólag egy felhatalmazott szakember végezheti el.
- Mindig ellenőrizze a zuhanytálcát a felszerelés előtt.
- A zuhanytálca telepítésekor mindig védje a tálca, a csempe és a falicsempek felületeit.
- A lefolyó telepítésekor kövesse a gyártó utasításait.
- Kerülje mindenféle szennyeződést, beleértve a hulladékokon hagyott szennyeződések is.
- Azokon a falakon, ahol a cserélhető panel található, tisztának, száraznak és zsírtalannak kell lenniük.
- A megfelelő telepítés biztosítása érdekében a munkalépéseket a megfelelő sorrendben kell elvégezni.

#### GARANCIÁLIS FELTÉTELEK

- Garanciális időszak:**  
A garancia a vásárlás dátumától számított 5 évig érvényes.
- A garancia hatálya:**  
Kiterjed az anyag- és gyártási hibákra, amelyek a rendeltetésszerű használat során derülnek ki.
- A garancia kizárásai:**
  - Mechanikai sérülések, amelyeket helytelen használat, szállítás vagy telepítés okoz.
  - Sérülések, amelyek agresszív vegyszerek vagy nem megfelelő ápolás következtében keletkeztek.
  - A termék természetes kopása (például kis karcolások, elszíneződések).
- A garancia fenntartásának feltételei:**
  - A termék ellenőrzése esetleges gyári hibák és megfelelő lejtésprofil szempontjából a telepítés előtt.
  - A telepítést a gyártó utasításainak megfelelően kell elvégezni.
  - A terméket csak az ajánlott tisztítószerekkel kell ápolni.
- Reklamációs eljárás:**
  - Hiba esetén a reklamációt a vásárlás helyén kell benyújtani, a vásárlási bizonylat és a hiba leírásának bemutatásával.
  - A gyártó fenntartja a jogot a termék javítására, cseréjére vagy a pénz visszatérítésére.
- Kapcsolat:**  
Minden kérdést vagy bejelentést a gyártó címére kell küldeni.



**BALNEO POLSKA**

tel: +48 22 740 72 74, +48 737 923 005, +48 799 787 334,

e-mail: biuro@balneo.pl

more information on: [www.balneo.pl](http://www.balneo.pl)



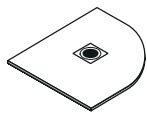

## МОНТАЖ НА ДУШ ПОДЛОЖКА

1. Начална проверка
2. Подготовка на основата
3. Монтаж на душ подложка
4. Почистване
5. Поддръжка
6. Указания



Нужни инструменти:  
Мярна лента, Малярска лента, Лепилен разтвор, Кофа, Ръкавици, Дозатор със силиконов уплътнител, Ниво, Отвертка, Молив, Мистрия



## 1. НАЧАЛНА ПРОВЕРКА

1.1 Проверете дали душ подложката не изглежда деформирана и дали няма удари или драскотини по нея. Проверете дали моделът, цветът и текстурата са правилни. След инсталация не се приемат замени или рекламации по гореспоменатите причини.

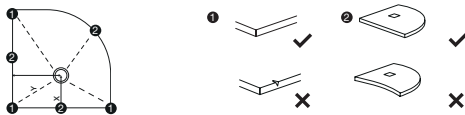

## 1.2

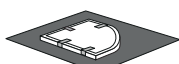

Душ подложката трябва да се съхранява в хоризонтално положение, като внимавате да не надраскате подложката с винтове или покритие.

## 1.3

Основна инсталация. Инсталация на ниво пода.

## 1.4

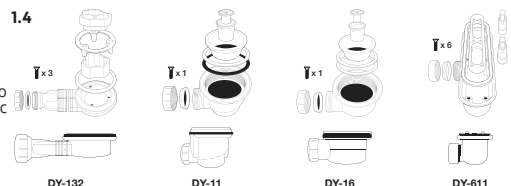

Проверете внимателно всички елементи на изпускателния клапан, които сте получили.

## 2. ПОДГОТОВКА НА ОСНОВАТА.

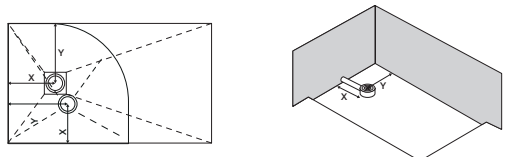

2.1 За да монтирате, изпускателят трябва да съвпада с центъра на изпускателя на душ подложката.

## 2.2

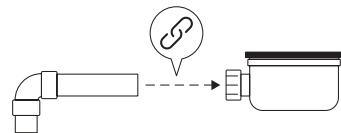

Проверете връзката между изпускател и изпускателна тръба, като се уверите, че при наливане на вода в изпускателя няма теч в съединението.

## 2.3

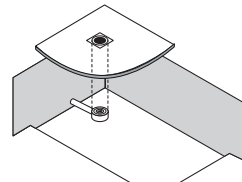

Монтирайте изпускателя така, че да съвпада с центъра на изпускателя на душ подложката.

## 2.4

Трябва да се осигури стабилна, не деформирана и напълно изравнена основа с циментов материал. Уверете се, че дупката около клапана не е по-висока от 2 см и не се намира под нивото на основата.

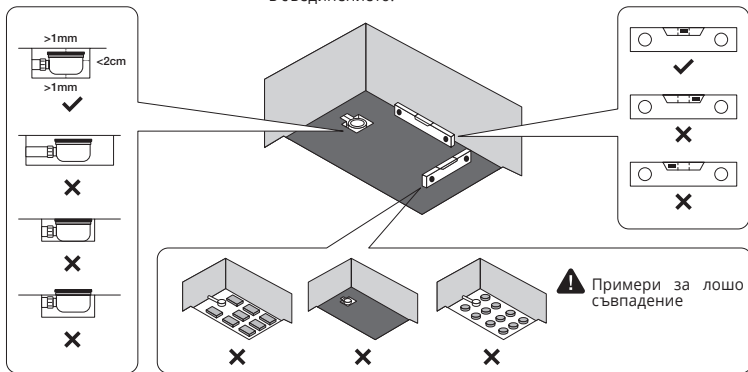

## 3. МОНТАЖ НА ДУШ ПОДЛОЖКАТА.

Преди да нанесете лепилото и да продължите с монтажа, поставете душ подложката на основата и свържете изпускателя. Налейте обилно вода. Проверете дали водата тече директно в изпускателя. Тази проверка е много важна, не приемаме рекламации, замени и възстановявания след монтаж на душ подложката.

## 3.1

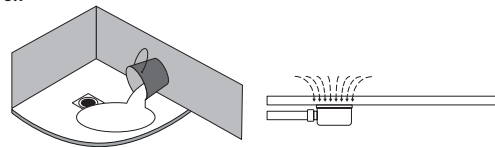

## 3.2 Монтаж на изпускателя

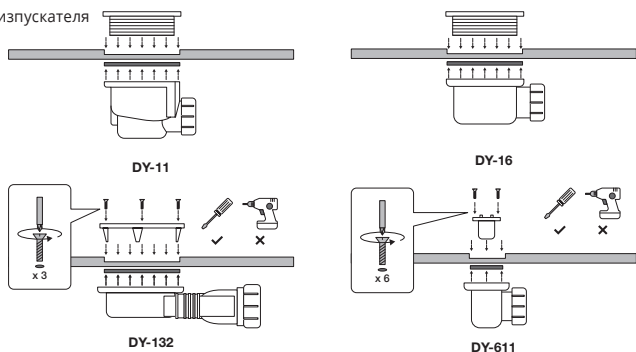

## 3.2

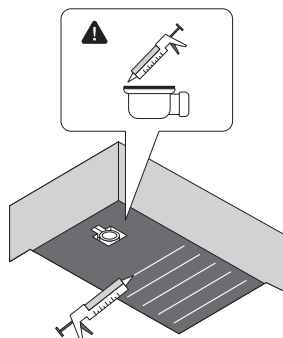

За да монтирате изпускателя, за безопасност, нанесете силиконов уплътнителен шнур.

След всички проверки и настройки, запечатайте със силикон по правите фуги.

## 3.4

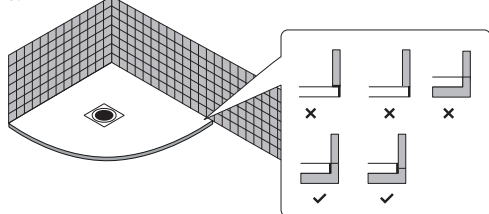

## 3.5

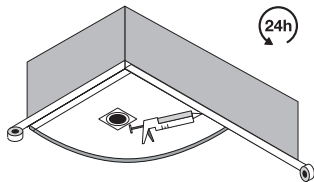

## 3.6

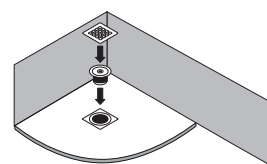

Закрепете душ подложката и завършете монтажа на кабината, необходимо е да оставите място от 2-3 мм, запълнено със силиконов уплътнител между душ подложката и стената, плочките, панелите или който и да е друг прилежащ елемент. Ако трябва да поставите плочки на душ подложката, уверете се, че тежестта не лежи директно върху подложката.

Предпазете душ подложката с маскираща лента преди запечатване и изолирайте връзката на душ подложката със стените със силикон. Оставете да съхне за 24 часа.

Поставете само изпускателна тръба в сифона и затегнете централния винт, поставете стоманеното покритие в квадратната вдлъбнатина в средата на душ подложката.

## 3.7

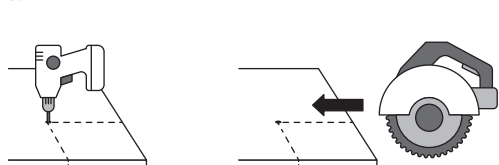

Пробийте дупка в точката на пресичане на двете линии на рязане, използвайте диамантен диск, за да изрежете от вълн на вътре към дупката, точно следвайки линията на рязане.

## 3.8

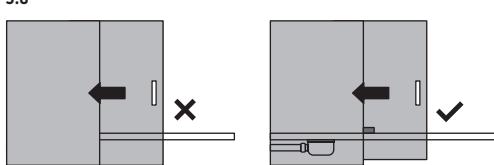

**ПРЕДУПРЕЖДЕНИЕ!** Никогa не местете метални профили или стъкло по душ подложката, за да избегнете надрасване. **ПРЕДУПРЕЖДЕНИЕ!** Не позволявайте остатъци от силикон да паднат върху душ подложката по време на монтажа на кабината.

## 3.9

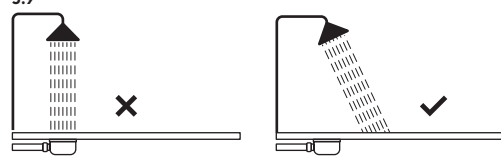

Предпоръчително е водата, която пръска от душа, да не тече директно върху покритието, тъй като това може драстично да намали капацитета на изпускателя на душ подложката.

#### 4. ПОЧИСТВАНЕ

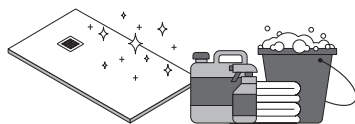
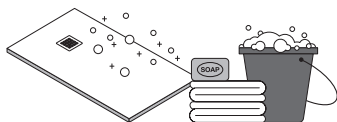

##### 4.1

##### За рутинно почистване:

Почистете душ подложката със сапун и вода, като помагате на почистването с мека кърпа или почистваща кърпа. Никога не използвайте абразивна гъба. Тъй като това е основно почистване, препоръчително е да се извършва ежедневно.

##### За дълбоко почистване:

Можете да използвате всеки търговски почистващ препарат, дори и най-силния, но винаги почиствайте след оставяне на продукта да действа няколко минути. Много е важно да не оставяте продукта върху душ подложката с часове, тъй като това може да причини нежелани петна. В този процес можете да използвате кърпа или почистваща кърпа, но никога не използвайте абразивна гъба.

##### Почистете след работа:

За почистване предлагаме да използвате сапун или подобен продукт. **НИКОГА НЕ ИЗПОЛЗВАЙТЕ НЕРАЖДАЕМА СТОМАНА ЧЕТКА (SCOTCHBRITE ИЛИ ПОДОБНА)**, нито разтворители, киселини или абразивни продукти. Носете ръкавици, защитна маска и очила.

##### 4.2

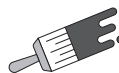

Продукт за боядисване на коса: Ако изпакнете веднага, душ подложката няма да бъде засегната. Ако боята остане върху душ подложката няколко минути по невнимание, ще остави петна. Тези петна могат да бъдат премахнати чрез ръчно пране.

Силиконови петна или подобни: За да премахнете този тип петна, използвайте парче дърво и внимателно разтривайте, докато петното изчезне. По-лесни са за премахване, ако почиствате с лимонена киселина или алкохол.

Работни петна: Петна от цимент, гипс и др.: В този случай се препоръчва използването на солна киселина. Оставете да действа 2-3 минути върху петното и след това изпакнете с вода. Процесът може да се повтори няколко пъти.

Боя петна: По-трудни за премахване. Най-доброто решение е да се шлифова засегнатата зона и да се преобоядиса с комплект за ремонт.

Варови петна: Варови петна върху всички тъмни цветове на душ подложката могат да бъдат проблем в някои географски райони. За да ги премахнете, можете да използвате всеки търговски продукт за отстраняване на варовик или тоалетен почистващ гел, съдържащ солна киселина. Отстранете неръждаемата стоманена решетка преди почистване с този тип химически продукт (ако е инсталирана).

#### 5. ПОДДРЪЖКА

##### 5.1



Gel de acoperire (200 ml)



Întăritor (15 ml)



Bloc de spumă



Șmirghel (320μm)



Placă de răzuit



Cârpă fără scame



Răzuitor

##### 5.2

1

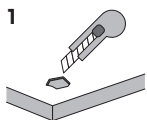

2

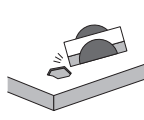

3

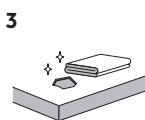

Използвайте стъргалка, за да отстраните покривния гел от повредената зона.

Използвайте шкурка, за да обвийте блок от пяна, след което шлифайте дефектната зона.

Нанесете ацетон или етилов алкохол с вода, като използвате безвлакнеста кърпа. Почистете много добре повърхността на душ подложката, повърхността трябва да бъде напълно чиста и суха.

4

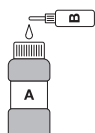

5

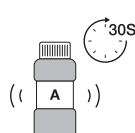

6

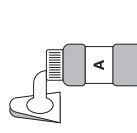

7

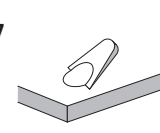

Пригответе ремонтния покривен гел и След това разклатете за 30 секунди. втвърдител в следните пропорции (покривен гел: втвърдител = 25:1).

Вземете малко ремонтен покривен гел с помощта на стъргалка.

Поправете повредената част, докато стане гладка.

##### 5.3

8

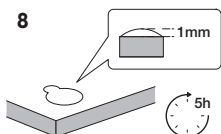

9

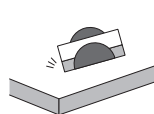

10

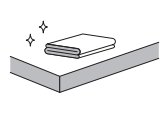

Накрая оставете да изсъхне за 5 часа.

Отново шлифайте зоната със шкурка, запазвайки текстурата на повърхността.

След това почистете повърхността със суха безвлакнеста кърпа и нанесете ацетон или етилов алкохол с вода, използвайки безвлакнеста кърпа.

#### 6. УКАЗАНИЯ

1. Транспортирайте душ подложката само в опаковката, избягвайте претоварвания.
2. Не поставяйте във вертикално положение.
3. Не носим отговорност за щети, причинени от неправилно съхранение или транспорт.
4. Инсталацията трябва да бъде извършена само от упълномощен специалист.
5. Винаги проверявайте преди да монтирате душ подложката.
6. По време на монтажа на душ подложката винаги предпазвайте повърхностите на подложката, плочките и стенните плочи.
7. За да инсталирате изпускателя, следвайте инструкциите на производителя.
8. Избягвайте всякакви замърсявания, включително тези, оставени върху отпадъците.
9. Стените, върху които се намира сменяемият панел, трябва да бъдат чисти, сухи и обезмаслени.
10. За да осигурите правилен монтаж, работните етапи трябва да бъдат изпълнени в правилната последователност.

#### УСЛОВИЯ НА ГАРАНЦИЯТА

1. **Период на гаранцията:**  
Гаранцията е валидна за 5 години от датата на покупка.
2. **Обхват на гаранцията:**  
Покрива дефекти на материалите и производството, открити при употреба съгласно предназначението.
3. **Изключения от гаранцията:**
  - Механични повреди, причинени от неправилна употреба, транспорт или монтаж.
  - Повреди, произтичащи от употребата на агресивни химикали или неправилна поддръжка.
  - Естествено износване на продукта (напр. малки драскотини, обезцветяване).
4. **Условия за поддръжане на гаранцията:**
  - Проверка на продукта за евентуални фабрични дефекти и правилно профилиране на наклона преди монтажа.
  - Монтажът трябва да се извърши в съответствие с инструкциите на производителя.
  - Продуктът трябва да се поддържа само с препоръчаните почистващи препарати.
5. **Процедура за рекламация:**
  - При установяване на дефект, рекламацията трябва да бъде подадена на мястото на покупката, като се представи доказателство за покупката и описание на дефекта.
  - Производителят си запазва правото да ремонтира, замени продукта или възстанови парите.
6. **Контакт:**  
Всички въпроси или оплаквания трябва да бъдат насочени към адреса на производителя.



**BALNEO POLSKA**  
tel: +48 22 740 72 74, +48 737 923 005, +48 799 787 334,  
e-mail: biuro@balneo.pl  
more information on: [www.balneo.pl](http://www.balneo.pl)

